

CITY OF NORTH PORT ADMINISTRATIVE APPEAL

IN RE: Appeal of MAS-23-160 by Heron Creek Community Association, Inc.

HERON CREEK ASSOCIATES, LTD AMENDED RESPONSE TO APPEAL OF MAS-23-160 BY HERON CREEK COMMUNITY ASSOCIATION. INC.

Heron Creek Associates, Ltd. (the “Developer”) files this Response in support of the City of North Port Development Order, MAS-23-160, a Major Site and Development Plan for a 150-unit residential condominium development on Parcel K in Heron Creek as follows:

Heron Creek Associates, Ltd. (the “Developer”), supports the City of North Port Development Order, MAS-23-160, a Major Site and Development Plan for a 150-unit residential condominium development on Parcel K in Heron Creek. The Developer opposes the appeal thereof by Heron Creek Community Association, Inc. (the “Association”).

The Developer owns Parcel K and is the applicant for the site plan approval that is the subject of the challenges. Accordingly, the Developer stands to be adversely impacted by any change to the Development Order MAS-23-160.

As background, since 1997, the Developer has been in the process of developing the Heron Creek Community as part of a multi-phase project, pursuant to the Heron Creek DRI Development Order, which has been amended multiple times, the most recent embodiment of which is Ordinance 2013-16. The Heron Creek Community has served to boost the growth of the City of North Port and support its expanding economy and presence in southwest Florida.

The Developer hereby provides this written response, to be supplemented by oral argument at the hearing on the appeal, to the grounds raised by the Association’s appeal and requests that each ground be denied:

Count 1 – Staff properly exercised their jurisdiction to approve MAS-23-160

The Association erroneously argues that the staff of the City’s Development Services Department lacks jurisdiction to approve a Major Site and Development Plan such as MAS-23-160 because the provisions of the ULDC confer such jurisdiction only to the City Commission and the Planning and Zoning Advisory Board (PZAB). The Association is incorrect.

Sec. 33-8., entitled “Procedure for securing major site and development plan approval,” makes it clear that it is staff that approves the major site and development plans.

Subsection (D) of Sec. 33-8, provides (emphasis added):

D. *Review of application.* Upon a determination that the plans submitted are complete, the application shall be logged into the City's database and placed on the staff review schedule.

(1) The City staff shall review the plans within a timely manner of receipt of the application. Depending on the size of the proposed development, a longer period of review time may be required by the City staff but shall not exceed sixty (60) days.

(2) Upon receipt of all comments by the City staff, a master list of the comments shall be transmitted to the applicant.

(a) The decision of each City staff may be: Meets Requirements, Meets Requirements with Conditions, No Objection, Does Not Meet Requirements, Continuance.

(b) If the applicant receives a finding of "Does not meet requirements," the applicant shall resubmit the petition with all required changes to bring the project into conformance with the Unified Land Development Code, Urban Design Standards Pattern Book, any other City Code which applies, and any State, County, or Federal regulations.

(3) Upon resolution of all outstanding issues and a unanimous decision of "Meets Requirements," "Meets Requirements with Conditions," or "No Objection" by the City staff, the applicant shall submit all required copies of the final plans showing all required corrections within ten (10) days of the City staff's final findings sent to the applicant.

(4) Upon receipt of the final corrected plans, the plans shall be stamped approved and a development order shall be issued to the applicant.

(a) A development order is required to secure a development permit.

Accordingly, City staff have jurisdiction to approve major site and development plans, and thus City staff properly exercised their jurisdiction to approve MAS-23-160.

Count 2 – No Violation as to Density

The Development Order MAS-23-160 properly approves Parcel K for 150 units. The Association's argument in opposition fails and ignores the history of the Heron Creek development and the City's authorization of the same, which supports the approved density level. In short,

Appellant mistakenly ties density to a parcel by parcel basis rather than a calculation of overall density as called for by both the original zoning for the property as well as the subsequent DRI approval.

In 1997, even prior to the 2000 DRI approval, 807 acres of Heron Creek (Phase 1) were rezoned to the PCD district by Ordinance No. 97-2. Attached to that ordinance was a copy of the rezoning request in which it is stated: “*Consistent with the Future Land Use Map designation of Low Density Residential, the residential component for Phase 1 will not exceed an overall density of greater than 4.0 du/acre.*” (“Phase 1” consisted of the increment of development that could legally take place pursuant to a preliminary development agreement prior to the approval of the DRI.) The DRI approval later adopted the same methodology.

The PCD and DRI approvals authorize both single family and multifamily units. DRI Map H specifies where residential uses can be located, and without differentiating single family and multifamily units. Instead, the DRI simply reflects “residential use” as being appropriate in areas designated on the Future Land Use Map (FLUM) as Activity Center and in areas designated as Low Density.

Moreover, the ULDC itself provides that: “*Unless specifically noted in the context of its use, density means dwelling units per gross acre*”; and a PCD is “*A large-scale development whose essential features are definable boundary; a consistent, uniformed character; overall control during the development process by a single development entity...*” Thus, Heron Creek’s density must be calculated based on the gross acreage of lands designated for Low Density within the PCD and DRI boundaries.

It was based on the foregoing reasoning that staff supported, and the Commission approved, multifamily use on Parcel K in 2009, since the overall density of Heron Creek’s unplatted acres within the Low Density areas, when viewed as a whole, would remain significantly below the 4.0 du/acre threshold.

As a practical matter, this methodology is the only reasonable interpretation of the DRI approval. The DRI originally approved 1,067 multifamily units (which Heron Creek later voluntarily reduced). Development of that number of units would not have been feasible if their placement were to be confined solely to the Activity Center—some of them would have necessarily spilled over to areas that the FLUM designated as “Low Density”.

More recently, the City sought a legal opinion from outside counsel Jennifer Cowan of Bryant Miller Olive on the issue of whether, under the current development order, multifamily units can be developed on Parcel K of Heron Creek, which has a land use designation of Low Density Residential, or whether the Developer will need to seek a comprehensive plan amendment changing the land use designation.

In response, on January 3, 2024, Attorney Cowan provided a detailed legal analysis and concludes that the developer is authorized to build multifamily development on Parcel K. *See attached Memorandum.* The City noted that Attorney Cowan’s analysis differs from an earlier 2022 response based on significant changes in the information available for the legal review. This

new information includes: (1) the Planning Division's new detailed analysis, supporting methodology, and calculation of the number of residential units; and (2) substantial background documentation for the DRI and prior comprehensive plan amendments. The new methodology complies with the comprehensive plan calculating the density based on 4 units per gross acre of the unplatted residential lands (± 381 acres), rather than the Parcel K site (± 15 acres).

Ms. Cowan's legal opinion of January 3, 2024 makes the following points:

- Comprehensive Plan Policy 1.1. states that: "*Low Density Residential - These lands are designated for residential areas of low density (for currently platted single family lots: maximum density of 4.3 residential units per gross acre, 4.0 residential units per gross acre for unplatted areas).*"
- Accordingly, Ms. Cowan notes that the "unplatted" areas consist of 381 acres, which would support 1,524 units. Parcel K will add 150 units, which when added to the *existing* 372 single family homes, will allow still another 1,002 units in the Low Density area without the 4.0 du/acre threshold being exceeded.
- Even if the calculation were based on "net" acreage (even though the ULDC says, "density means dwelling units per *gross* acre"), the result would be the same. Eight separate tracts (A, B, C, D, E, F, G and K) are within the Low Density area, and they total 138.37 acres in the aggregate, exclusive of roadways, walkways, etc. that support them. Those tracts would accommodate 553.48 units without exceeding the 4.0 du/acre threshold.

Accordingly, Parcel K is properly approved for 150 residential units. The number of residential units including those proposed for the multifamily development on Parcel K does not exceed the maximum established in the DRI.

Count 3 – No Violation of Comprehensive Plan Policies as to Flood Zones

Appellant further argues that Parcel K contains some areas of FEMA Flood Zone AE, whereas Comp Plan Policy 9.26 calls for the City to "discourage densification and intensification of land uses" within Flood Zone AE. However, Policy 9.26 must be read together with its companion, Policy 9.25.

Policy 9.25 prohibits "**unmitigated** development in 100-year floodplains..., that would adversely affect the function of the floodplains or that would degrade the water quality of water bodies associated with said floodplains..." The testimony below was that any impacts to floodplains had been *mitigated*.

While Parcel K contains some areas of FEMA Flood Zone AE, based on a plain reading and application of both Policy 9.25 and Policy 9.26, there is no violation of the Comprehensive Plan.

Count 4 – No Violation of Comprehensive Plan Policies as to Compatibility

Appellant interprets Policies 1.2.4 and 1.2.6 as requiring an analysis of compatibility when increased density is proposed. However, Appellant is again mistaken and appears to be citing the wrong policies. The cited policies deal not with compatibility, but with sidewalks and the safe school program. Appellant correctly cites Policy 9.27 but that merely calls for “potential incompatibilities between land uses due to the density,... of use proposed” to “be mitigated through site and architectural design techniques...”

Here, the higher density residential on Parcel K is not inherently incompatible with single family residential use, especially when separated by a boulevard. This is particularly true given the site and architectural design techniques intended to be constructed here: a boulevard and the golf course with fairways and dense vegetation separate the multifamily residential units from the single family residential units. *See the attached Site Plan*. No multifamily units abut single family units.

Further, the DRI permits different uses and the City’s Comprehensive Plan promotes different housing types. To argue then that the different uses are per se incompatible would fly in the face of the very mixed use goal of the DRI itself.

Count 5 – Sufficient Multifamily Units Exist in the DRI and Proper Categorization of ALF

The Association challenges the Developer’s ability to develop additional multifamily units based on an argument that assisted living facilities should be considered residential (and thus reduce the number of residential units available to Heron Creek for Parcel K). Again, Appellant is mistaken.

First, the City already determined that “The Assisted Living Facility is categorized under general office,” as memorialized in Nicole Galehouse’s March 17, 2020 correspondence to the Developer. *See attached email*. The Association’s challenge to this determination is meritless.

Second, pursuant to the land use conversion matrix in the DRI Order, the Developer nonetheless still has a sufficient number of remaining multifamily units to develop the 150 multifamily units on Parcel K. This is because the Developer is able, pursuant to its rights and entitlements under the DRI Order and the conversion matrix therein, to convert some of its other categories of land uses (medical/professional, office general, or retail shopping center) to residential multifamily.

Count 6 – Covenants and Restrictions of Condominiums Not Required to be Recorded

The Association incorrectly contends that the ULDC “submission requirement[s]” apply to the proposed condominium development on Parcel K and therefore a Condominium plat is required. Again, Appellant is mistaken on this point.

Section 33-9-A (22) does not specifically mention declarations of condominiums and therefore the Developer is not required to submit covenants and restrictions to the City for review and to record the same prior to the issuance of MAS-23-160.

As a practical matter, condominium plats are an expensive and time consuming process. It would make little sense to require a developer to obtain a plat recording before obtaining the development approval for the very condominium it is recording.

Count 7 – Compliance with Traffic Impact Study

Appellant argues that the lack of a traffic study is grounds for reversing the City’s decisions. Again, this argument is misdirected. There is no requirement for the Traffic Impact Statement to include analysis of the adjacent roadways as that was already taken into account with the overall Traffic Analysis for the DRI. The submitted study was only required to verify the number of proposed trips and analyze whether turn lanes into the project were required. All other offsite turn lanes or road improvements were already addressed with the DRI.

Developer’s consultant Matt Morris, P.E. did submit a Traffic Impact Statement for Parcel K. The City accepted this Study in granting its review. While not signed and sealed at the time of the hearing, it has been or is the process of being signed and sealed with no changes.

Count 8 – Compliance with Water and Sewer Impact Requirements

Appellant contends that, in using the land use conversion matrix to convert 102,380 sf of Retail Shopping Center to 430 Multi-Family units. Developer failed to address the provision in that matrix requiring that “no additional impact will occur to other public facilities (such as water and sewer).” Specifically, Appellant argues that the provision is not aimed at *capacity* of the *system*, but rather whether the conversion results in “additional impact”. Once more, the Association’s challenge fails.

As an initial matter, the issue of impacts was addressed. In the letter by Developer representative Ron York on January 25, 2023 the Developer acknowledged that the DRI grants no guarantee of entitlement to water and sewer service going forward; so, applying the matrix to convert uses has no effect on utility service.

More specifically, Section 78-30 of the ULDC specifies how equivalent residential connections (ERCs) are to be calculated for residential uses. It says that a multifamily unit translates to one ERC. However, the determination of ERCs for non-residential uses, such as a

Retail Shopping Center, is more complicated. For *water* service, it is determined by multiplying the number of fixture units by 20, then dividing that numerator by 170; and for *wastewater* service, it is determined by multiplying the number of fixture units by 20, then dividing that numerator by 155. Therefore, if the question is whether the conversion from retail to residential imposes additional impact, we must look at it in the context of the original DRI when 1,970 residential units (903 single family and 1,067 multifamily) were approved, far more than the mere 1,653 units (903 single family and 750 multifamily) achieved as a result of the January 25, 2023 conversion. Thus, the Developer is in compliance.

Count 9 – The Developer Rightfully and Properly Shifted Land Uses Pursuant to the Land Use Conversion Matrix in the DRI Order

The Appellant points to the provision in the land use conversion matrix that says that the “conversion [may] not increase the allotted number of units...” so as to “exceed the substantial deviation criteria of subsection 380.06(19)(b).” From there, the Appellant argues the proposed use triggers substantial deviation review. Again, Appellant is mistaken.

As a preliminary matter, Attorney Cowan’s October 15, 2021 Memorandum succinctly addresses the Developer’s entitlement and ability to shift land uses pursuant to the conversion matrix in the DRI. *See attached.* The Memorandum further provides the legal authority for interpreting development orders and legal analysis supporting her conclusion that “the Development Order is clear and unambiguous as to the . . . ability of the Developer to modify the Land Use Table by transferring land uses amongst phases of the development without further amendment of the Development Order and subject to the conditions of transfer or conversion therein.” The Developer adopts and incorporates Ms. Cowan’s Memorandum in full.

The Developer’s shifting of land uses is in compliance with the “conditions of transfer or conversion” in the DRI, including the “substantial deviation criteria of subsection 380.06(19)(b), F.S.” This requirement is found in Section 3.01(d) of Ordinance 2011-33.

Critically, Section 380.06(19)(b), Florida Statutes (2011), was repealed in 2018.

However, even if the statute were to somehow survive its repeal, the Developer is nonetheless in compliance with the substantial deviation criteria therein from 2011. The repealed statutory provision defined a “substantial deviation” as one that involves an increase in residential units by more than 50 percent or 55 units.

The legislative intent of the North Port City Commission in cross referencing subsection 380.06(19)(b) was to ensure that deployment of the conversion matrix would operate within the bounds of then-existing DRI law and not unwittingly trigger a substantial deviation, thus inviting further regional and state review. With the statute’s repeal, that concern has evaporated. Moreover, even if Section 380.06(19)(b) were still in effect, the threshold for determining a substantial deviation should be the 1,970 units approved in the year 2000. Accordingly, the 2023 conversions resulted in a decrease, not an increase, in residential units.

CONCLUSION

Based on the above, the Developer requests that the Association's appeal of MAS-23-160 be denied in full.

The Developer requests notice of the hearings in this matter.

For **Heron Creek Associates, Ltd.**

BENTLEY GOODRICH KISON, P.A.



12/6/24

MORGAN R. BENTLEY, ESQ.

Florida Bar No. 0962287

CAROLEEN B. BREJ, ESQ.

Florida Bar No. 0093188

783 S. Orange Avenue, 3rd Floor

Sarasota, Florida 34236

Telephone: (941) 556-9030

Primary Email: mbentley@bgk.law

Secondary Email: cbrej@bgk.law

Secondary Email: eserve@bgk.law

Bryant Miller Olive

Attorneys at Law
One Tampa City Center
Suite 2700
Tampa, FL 33602
Tel 813.273.6677
Fax 813.223.2705
www.bmolaw.com

January 3, 2024

VIA PDF EMAIL

Amber L. Slayton, Esq., City Attorney
City of North Port
4970 City Hall Boulevard
North Port, Florida 34286
aslayton@cityofnorthport.com

Re: Heron Creek Comprehensive Plan – Parcel K

Dear Amber:

You have requested that we provide the City of North Port (“City”) with a written opinion on whether, under the current development order, multifamily units can be developed on Parcel K of Heron Creek, which has a land use designation of Low Density Residential, or whether the Developer will need to seek a comprehensive plan amendment changing the land use designation. This letter will address only the issue regarding whether a comprehensive plan amendment is needed as it relates to the land use designation of Parcel K and will not discuss zoning or other land development related matters.

I. Background

In responding to your request, we have reviewed the following materials provided by the City:

- Memorandum from the Development Services Department to Amber Slayton regarding Heron Creek Residential Entitlements Under the

Development of Regional Impact and Neighbor Meeting Requirements, dated October 2, 2023;

- Interoffice Memorandum From Margaret Roberts to A. Jerome Fletcher II, regarding Analyze Parcel K Issue – Heron Creek, dated January 20, 2022
- Letter from Noah Fossick to Matt Morris regarding requirements for Heron Creek Parcel K dated May 30, 2023;
- Order on Defendants/Counterclaim Plaintiffs’ Amended Motion for Partial Final Summary Judgment on Counter-Claim and Cross-Claim, in Heron Creek Associates, Ltd. V. Steve Dsupin, et al (Case No. 2020 CA 4364 NC)
- Ordinances 2000-13 with Map H, 2005-28, 2006-46, 2011-33 with Map H, 2013-16;
- Marsh Creek Questionnaire Checklist for DRI ADA Submission
- Multiple correspondence from Department of Community Affairs in 1996, 1997, 2001
- BMO’s Letter regarding Heron Creek Land use and Conversion Table dated October 15, 2021;
- Comprehensive Plan 1988-1998, adopted March 15, 1989
- Comprehensive Plan, adopted November 10, 1997, amended July 1999, and amended May 28, 2002 (this was provided as one document without detailed information of the revisions in 1999 and 2002).
- Comprehensive Plan, adopted June 27, 2017
- Applicant’s Calculations
- Staff’s Calculations

A. Comprehensive Plans

In the Comprehensive Plan 1988-1998, the City identifies in its Future Land Use Plan, Guiding Growth Management Strategy, that it anticipates the majority of growth in the City will occur contiguous to the present developed area. This area is anticipated to have low, medium, and high-density residential growth areas and that within this urban infill area, public services and facilities can be economically and efficiently extended to meet the needs of the projected population. The Comprehensive Plan 1988-1998 shows Heron Creek in two future land use categories, with Parcel K being in the Low Density Residential (Undeveloped) land use category. Policy 1.2 of the Future Land Use Element provides that Low Density Residential is a maximum of 4 residential units per gross acre, medium density residential is 4.1-10 residential units per gross acre, and high density residential is 10.1 to 15 residential units per gross acre. The Comprehensive Plan 1988-1998 only speaks of residential units but does not specify whether the residential units

must be single-family or multifamily or both in the same development. At the time Heron Creek applied for its development approval, the Comprehensive Plan 1998-1998 was in effect.

When Heron Creek's Development Order was approved, the Comprehensive Plan adopted Nov. 1997, amended July 1999, and amended May 28, 2002 ("1997 Comprehensive Plan") was in effect. In the 1997 Comprehensive Plan, the City no longer identifies the Urban Infill Area on its Future Land Use Map. Instead, the Heron Creek property is divided into two primary land use categories on the Future Land Use Map: Activity Center (Town Center), which provides for governmental, low, medium and high densities, offices, commercial and medical facilities; and Low Density Residential. Heron Creek's Parcel K remains located in the Low Density Residential land use category. Pursuant to Policy 1.1 of the Future Land Use element, Low Density Residential are lands are designated for residential areas of low density, with a maximum of 4 residential units per gross acre for unplatted areas (for currently platted single-family lot maximum density of 4.3 residential units per gross area) . The 1997 Comprehensive Plan specifies single-family in currently platted lots with a maximum density of 4.3 units per gross acre but does not specify the type of residential units when setting the gross acre density for unplatted land.

In the current Comprehensive Plan Adopted June 27, 2017 (the "2017 Comprehensive Plan"), Heron Creek is still divided into two primary land use categories on the Future Land Use Map: Activity Center and Low Density Residential, with a small area designated for Recreation/Open Space. Figure 1 provides the density and intensity of the Activity Center at Heron Creek. In Policy 1.1 of the Future Land Use Element, Low Density Residential remain the same as in the Comprehensive Plan; Low Density Residential are lands with a maximum of 4 residential units per gross acre for unplatted areas. Again, the 2017 Comprehensive Plan does not specify whether the residential units for unplatted land must be single-family or multifamily or both in the same development.

From the time of application through current day, Parcel K has continued to be designated as Low Density Residential on the Future Land Use Map for the Comprehensive Plan 1988-1998, 1997 Comprehensive Plan, and the 2017 Comprehensive Plan. Each of these plans has provided that Low Density Residential are lands with a maximum of 4 residential units per gross acre for unplatted areas and did not specify whether the residential units in unplatted lands must be single-family or multifamily or both in the same development. Due to these consistencies, the Comprehensive Plan 1988-

1998, 1997 Comprehensive Plan, and the 2017 Comprehensive Plan will be referred to as the "Comprehensive Plan" and my analysis is applicable to each.

B. Ordinance 2000-13

On November 7, 1996, Marsh Creek applied for development approval in accordance with Section 380.06, Fla. Stat. for a development of regional impact ("DRI") to be known as Marsh Creek DRI, which is now known as Heron Creek. Heron Creek was a master planned community to be developed on an 831.38 acre unplatted parcel of land.

On September 11, 2000, the City Commission ("Commission") adopted Ordinance 2000-13 as the development order for Heron Creek, a development of regional impact. In that ordinance, the Commission found that, subject to the conditions found in the ordinance, the application for development approval (proposing 1,970 residential units (903 single-family and 1,067 multifamily units), as well as retail, office, recreation, golf, tennis, conservation, and roadways throughout the development) was consistent with the Comprehensive Plan and did not appear to conflict with other local land development regulations. Map H, which was part of the application for development approval and served as the preliminary master site plan, provides a site data table showing the total number of residential multifamily and single-family units and shows designated parcels identifying the acreage and use. For parcels that are designated as residential, there is not a specific designation of multifamily or single-family.

C. Subsequent Ordinances

From 2000-2013, this development order was amended several times and, ultimately the number of approved multifamily residential units was reduced from 1,067 to 300 units. Further, in Ordinance 2011-33, the Commission approved an updated Map H with existing and proposed development (removing the specification of parcel acreage), however, Map H continued to provide a site data table showing the total number of residential multifamily and single-family units and showing designated residential parcels without specifying the type of residential units that would be placed on the parcels. Ordinance 2011-33 also addressed affordable housing stipulations, revised the current stipulations relating to the proposed pathway along the Myakkahatchee Creek, and approved a land use conversion matrix that would allow the developer to convert approved uses from one to another without increase in external impacts. Specifically, the developer had explained that, the intent of the conversion matrix was

not to eliminate any intended land uses from development, but rather to allow for the reallocation of the quantities that are approved based on changes in the market demand due to changing market conditions. The conversion matrix provided that single-family residential, multifamily residential, retail, offices and medical offices could each be converted to the other through the local development order process without exceeding thresholds that would trigger a substantial deviation to the DRI. Use of the conversion matrix was subject to several conditions including that the transfer or conversion could not further alter Map H and did not increase the allotted number of units on any particular parcel to a level above what is permitted in the DRI or the City's Land Development Code and did not exceed the substantial deviation criteria of subsection 380.06(19)(b), Fla. Stat. In each ordinance from 2000 to the last one in 2013 approving the Heron Creek development, the Commission found the proposed development to be consistent with the Comprehensive Plan.

D. Current Development

Under the Comprehensive Plan and by both City staff and the Applicant's calculations, it appears that Heron Creek has 381 unplatted gross acres located in the Low Density Residential land use category. Pursuant to the maximum allowable residential units per gross acre for unplatted areas under the City's Comprehensive Plan, the 381 acres of Heron Creek located in the Low Density Residential land use category could have as many as 1,524 residential units (4 times the total 381 unplatted gross acres = 1,524 residential units). Currently, the City and Applicant state that the 381 unplatted acres of Heron Creek currently contains only the residential development of 372 single-family homes.

II. Interpreting Comprehensive Plans and Development Orders

A comprehensive plan provides the principles, guidelines, standards, and strategies for the orderly and balanced future economic, social, physical, environmental, and fiscal development of the area that reflects community commitments, §163.3177, Fla. Stat. This plan is used to guide future decisions in a consistent manner, §163.3177, Fla. Stat. Specifically, after a comprehensive plan has been adopted all actions taken in regard to development orders shall be consistent with such plan as adopted. §163.3194(1)(a), Fla. Stat. Further, any development order shall be considered consistent with the comprehensive plan if the land uses, densities or intensities, and other aspects of development permitted by such order are compatible with and further the objectives,

policies, land uses, and densities or intensities in the comprehensive plan and if it meets all other criteria enumerated by the local government. S. 163.3194(3)(a), Fla. Stat.

A development order shall be interpreted using the fundamental principles applicable to statutes and ordinances. *Trafalgar Woods Homeowners Assn., Inc. v. City of Cape Coral*, 248 So. 3d 282, 284 (Fla. 2d DCA 2018). Hence, where the language of a development order is plain and unambiguous, there is no room for construction or interpretation, and the effect of the development order must be determined according to the literal meaning of the language therein. *Killearn Properties, Inc. v. Dept. of Community Affairs*, 623 So. 2d 771, 775 (Fla. 1st DCA 1993); *Rinker Materials Corp. v. City of N. Miami*, 286 So. 2d 552, 553–54 (Fla. 1973).

Moreover, once a DRI has been approved, the right to develop pursuant to the terms of the DRI vests. *Bay Point Club, Inc. v. Bay Cnty.*, 890 So. 2d 256, 258 (Fla. 1st DCA. 2004). Vesting means development rights obtained through a previously approved DRI are not lost by subsequent changes in the law. *Id.*

III. Legal Analysis

The Comprehensive Plan shows that 381 unplatted gross acres of Heron Creek are located in the Low Density Residential land use category. Pursuant to the maximum allowable residential units per gross acre for unplatted areas under the City's Comprehensive Plan, the 381 unplatted acres of Heron Creek located in the Low Density Residential land use category could have as many as 1,524 residential units. Currently, the City and Applicant state that the 381 unplatted gross acres currently contains only the residential development of 372 single-family homes and the Developer has proposed developing 150 multifamily residential units on Parcel K. If those 150 multifamily units were developed on Parcel K, the total number of residential units on the 381 unplatted acres would be 372 single-family units and 150 multifamily units, totaling 522 residential dwelling units, which is significantly less than the maximum (1,524 residential units) allowed under the City's Comprehensive Plan.

Furthermore, even if the analysis was conducted on net acres designated as residential under the DRI, Heron Creek would be below the maximum allowable residential units in the Low Density Residential land use category. Heron Creek has eight tracts (A, B, C, D, E, F, G, and K) identified as residential that are located within the Low Density Residential land use category on the Future Land Use Map. Those eight tracts of land total 138.37 net unplatted acres and seven of the eight tracts of land are developed;

Only Parcel K remains undeveloped. If the maximum allowable residential units were calculated on a net residential acre for unplatted areas, the eight residential tracts located in the Low Density Residential land use category could have as many as 553.48 residential units (4 times the total 138.37 acres = 553.48 units). Currently, the City and Applicant state that the 138.37 unplatted acres contains only the residential development of 372 single-family homes. The Developer has proposed developing 150 multifamily units on Parcel K and if those multifamily units were developed, the total number of residential units on the 138.37 unplatted net residential acres would be 372 single-family units and 150 multifamily units, totaling 522 dwelling units, which is less than the maximum (553 residential units) allowed under the City's Comprehensive Plan.

In the adoption of the Development Order (from the initial to the current ordinance), the Commission has continually found that the Development Order is consistent with the Comprehensive Plan and that it does not appear to be in conflict with other local land development regulations. The Development Order is clear and unambiguous as to the total number of residential units that was approved for Heron Creek. The Development Order is clear and unambiguous that residential development is to occur on Parcels A, B, C, D, E, F, G, H, I, and K. The Development Order at Map H does not specify whether the development of Parcel K is limited to single-family or multifamily dwelling units – only that it must be residential.

It is clear from the plain language of the Comprehensive Plan and Development Order that multifamily residential development can be developed on Parcel K without seeking a comprehensive plan amendment so long as Heron Creek does not exceed the maximum of 4 units per unplatted gross acre for the residential areas in the Low Density Residential land use category of the Future Land Use Map.

II. Conclusion

It is our opinion, that multifamily development can occur on Parcel K under the Comprehensive Plan so long as it does not exceed the maximum of 4 units per gross unplatted gross acre for the residential areas in the Low Density Residential land use category on the Future Land Use Map, and it complies with the Development Order and any requirements of the City's zoning and land development regulations.

Amber L. Slayton, Esq.

January 3, 2024

Page 8

Should you need anything further on this matter, please feel free to contact us.
Thank you for providing us the opportunity to assist the City in this matter.

Sincerely,

A handwritten signature in black ink, appearing to read 'Jennifer R. Cowan', with a stylized flourish at the end.

Jennifer R. Cowan, B.C.S.

BRYANT MILLER OLIVE, P.A.

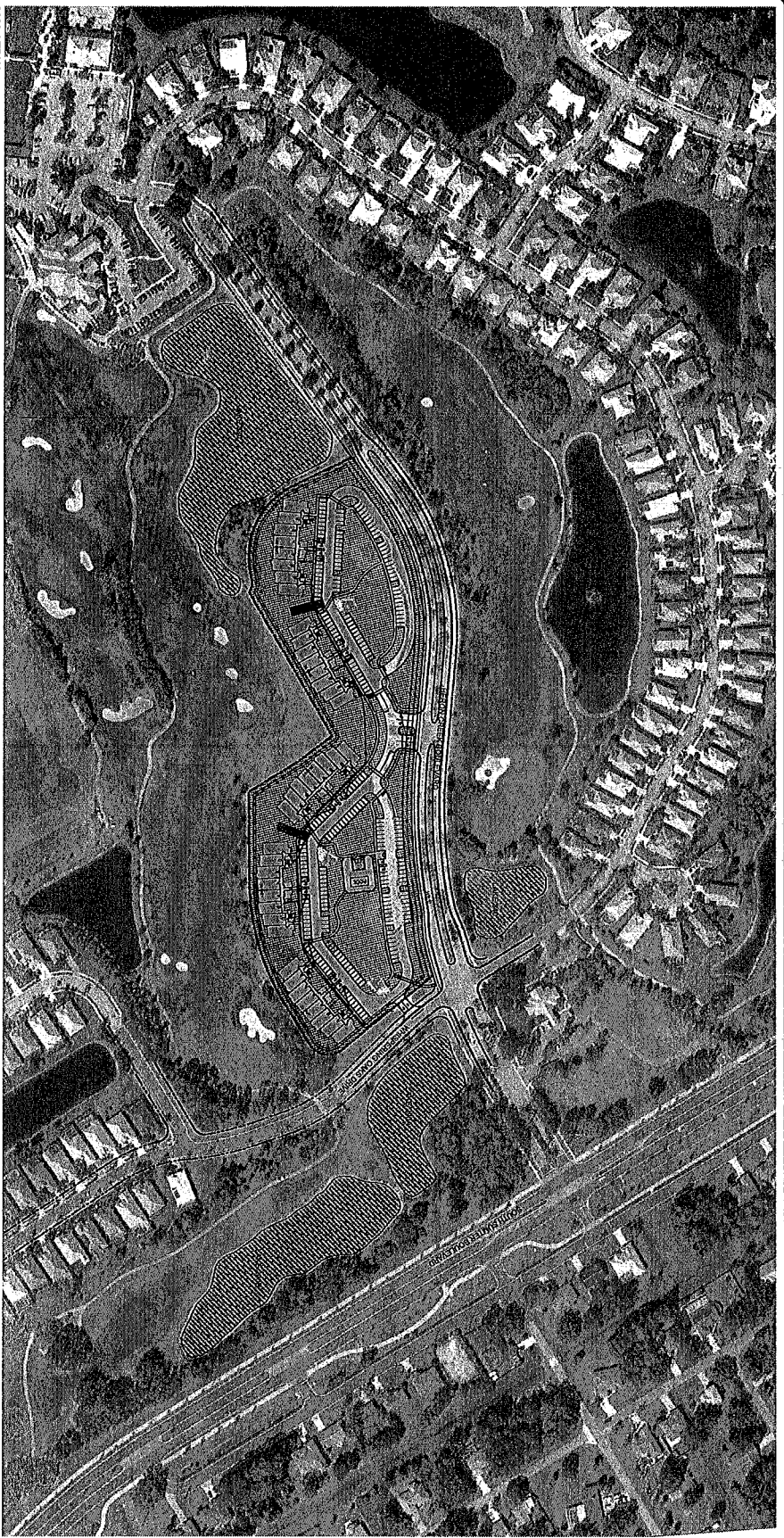

2022 AERIAL



PROPOSED FOR

Heron Creek Associates, Ltd.

4045 Lantana 100 Palm Lakes 3
 Orange 32834-0100
 407-255-0100



MORIS ENGINEERING AND CONSULTING, LLC
 Civil Engineering and Land Development Consulting
 3901 NW 14th Street, Fort Lauderdale, FL 33309
 P: 954-573-1200 F: 954-573-1201

NO.	DATE	DESCRIPTION
1	01/15/2022	PRELIMINARY
2	02/15/2022	REVISED
3	03/15/2022	REVISED
4	04/15/2022	REVISED
5	05/15/2022	REVISED
6	06/15/2022	REVISED
7	07/15/2022	REVISED
8	08/15/2022	REVISED
9	09/15/2022	REVISED
10	10/15/2022	REVISED
11	11/15/2022	REVISED
12	12/15/2022	REVISED

APPROVED FOR SUBMITTAL

DATE: 01/15/2022
 DRAWN BY: [Name]
 CHECKED BY: [Name]

HERON CREEK - PARCEL K
 AERIAL SITE MAP
 NORTH PORT, FLORIDA

2 of 11

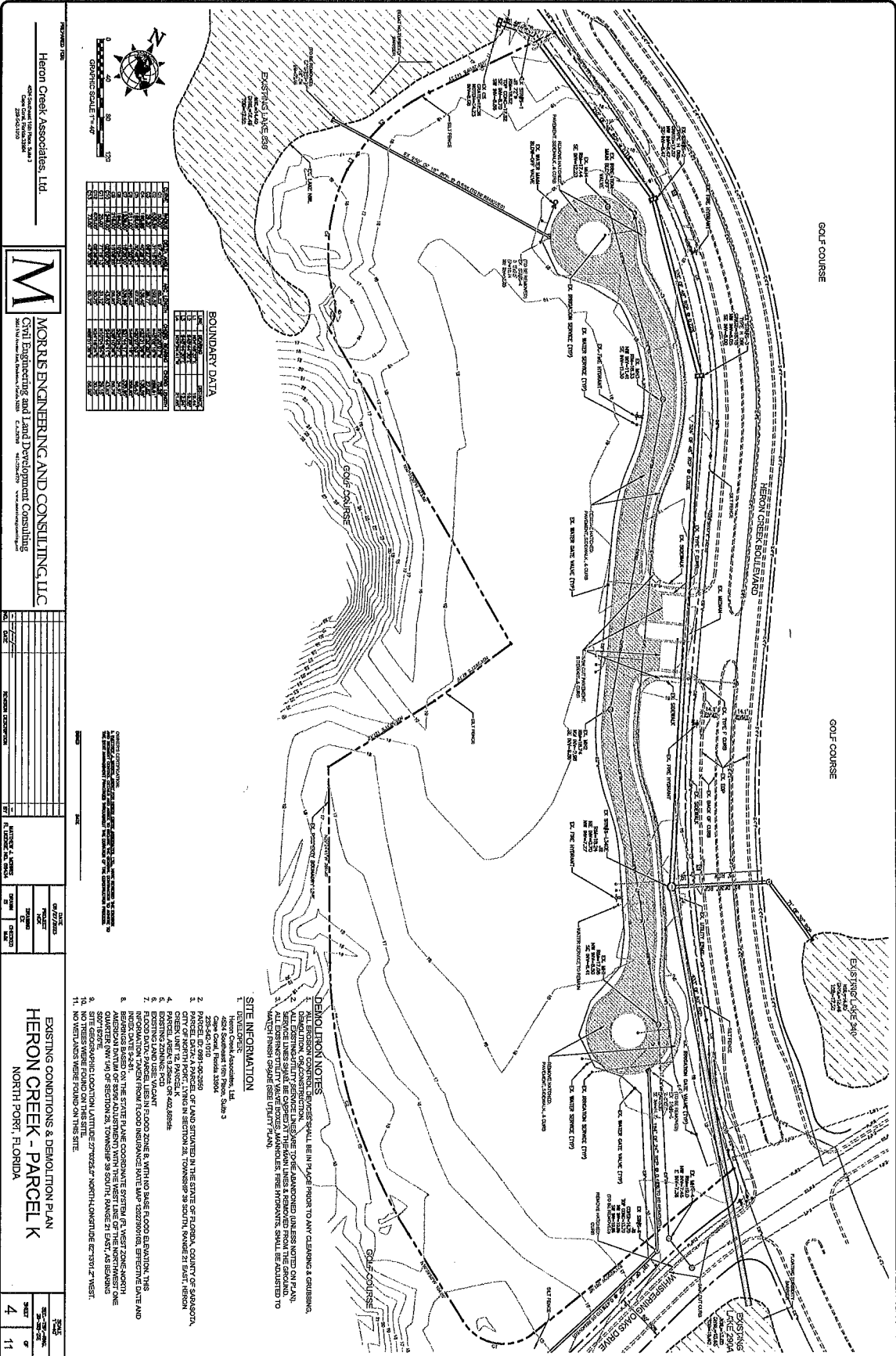

Heron Creek Associates, Ltd.
 4524 Southeast 17th Street
 Suite 200, Fort Lauderdale, FL 33304
 Phone: (954) 561-1111
 Fax: (954) 561-1112

M MORRIS ENGINEERING AND CONSULTING, LLC
 Civil Engineering and Land Development Consulting
 10000 North 15th Avenue, Suite 100
 Fort Lauderdale, FL 33322
 Phone: (954) 561-1111
 Fax: (954) 561-1112

NO.	DESCRIPTION	DATE	BY	CHECKED
1	PREPARED FOR			
2	PROJECT NO.			
3	DATE			
4	DRAWN			
5	CHECKED			
6	DATE			
7	BY			
8	CHECKED			
9	DATE			
10	BY			
11	CHECKED			
12	DATE			

EXISTING CONDITIONS & DEMOLITION PLAN
HERON CREEK - PARCEL K
 NORTH PORT, FLORIDA

DATE	BY	CHECKED
11/11/11	4	11

BOUNDARY DATA

NO.	DESCRIPTION	DATE	BY	CHECKED
1	...			
2	...			
3	...			
4	...			
5	...			
6	...			
7	...			
8	...			
9	...			
10	...			
11	...			
12	...			

DEMOLITION NOTES

1. ALL EMISSION CONTROL DEVICES SHALL BE IN PLACE PRIOR TO ANY CLEANING & GRUBBING.
2. DEMOLITION OF CONSTRUCTION EQUIPMENT SHALL BE TO BE ABANDONED UNLESS NOTED ON PLAN.
3. SERVICE LINES SHALL BE COVERED AT THE DOWN LINES & REMOVED FROM THE GROUND TO MATCH FINISH OR BEST PRACTICE.
4. MATCH FINISH OR BEST PRACTICE SHALL BE ACHIEVED TO MATCH FINISH OR BEST PRACTICE.

SITE INFORMATION

1. DEVELOPER: Heron Creek Associates, Ltd.
2. PROJECT NO.: 2009-100-2000
3. PARCEL ID: 0997-100-2000
4. CITY OF NORTH PORT: LIVING IN SECTION 22, TOWNSHIP 29 SOUTH, RANGE 21 EAST, HERON QUARTER, NW 1/4 OF SECTION 22, TOWNSHIP 29 SOUTH, RANGE 21 EAST, AS SHOWN ON MAP.
5. EXISTING ZONING: R-10
6. EXISTING ZONING: R-10
7. FLOOD DATA: PARCEL LIES IN FLOOD ZONE B, WITH NO BASE FLOOD ELEVATION. THIS INFORMATION TAKEN FROM FLOOD INSURANCE RATE MAP #2227900100, EFFECTIVE DATE AND REFERENCE BASED ON THE STATE PLANE COORDINATE SYSTEM AT WEST ZONE-NORTH QUARTER, NW 1/4 OF SECTION 22, TOWNSHIP 29 SOUTH, RANGE 21 EAST, AS SHOWN ON MAP.
8. SPOT ELEVATION: SPOT ELEVATION LATTICES 277955.27' NORTH, 408191.27' WEST.
9. NO TREES WERE FOUND ON THIS SITE.
10. NO TREES WERE FOUND ON THIS SITE.
11. NO TREES WERE FOUND ON THIS SITE.

- SYMBOL LEGEND**
- 1. EXISTING
 - 2. PROPOSED
- STREETS/LEGEND**
- 1. 2" WIDE DRIVE
 - 2. 4" WIDE DRIVE
 - 3. 6" WIDE DRIVE
 - 4. 8" WIDE DRIVE
 - 5. 10" WIDE DRIVE
 - 6. 12" WIDE DRIVE
 - 7. 14" WIDE DRIVE
 - 8. 16" WIDE DRIVE
 - 9. 18" WIDE DRIVE
 - 10. 20" WIDE DRIVE
 - 11. 22" WIDE DRIVE
 - 12. 24" WIDE DRIVE
 - 13. 26" WIDE DRIVE
 - 14. 28" WIDE DRIVE
 - 15. 30" WIDE DRIVE
 - 16. 32" WIDE DRIVE
 - 17. 34" WIDE DRIVE
 - 18. 36" WIDE DRIVE
 - 19. 38" WIDE DRIVE
 - 20. 40" WIDE DRIVE
 - 21. 42" WIDE DRIVE
 - 22. 44" WIDE DRIVE
 - 23. 46" WIDE DRIVE
 - 24. 48" WIDE DRIVE
 - 25. 50" WIDE DRIVE
 - 26. 52" WIDE DRIVE
 - 27. 54" WIDE DRIVE
 - 28. 56" WIDE DRIVE
 - 29. 58" WIDE DRIVE
 - 30. 60" WIDE DRIVE
 - 31. 62" WIDE DRIVE
 - 32. 64" WIDE DRIVE
 - 33. 66" WIDE DRIVE
 - 34. 68" WIDE DRIVE
 - 35. 70" WIDE DRIVE
 - 36. 72" WIDE DRIVE
 - 37. 74" WIDE DRIVE
 - 38. 76" WIDE DRIVE
 - 39. 78" WIDE DRIVE
 - 40. 80" WIDE DRIVE
 - 41. 82" WIDE DRIVE
 - 42. 84" WIDE DRIVE
 - 43. 86" WIDE DRIVE
 - 44. 88" WIDE DRIVE
 - 45. 90" WIDE DRIVE
 - 46. 92" WIDE DRIVE
 - 47. 94" WIDE DRIVE
 - 48. 96" WIDE DRIVE
 - 49. 98" WIDE DRIVE
 - 50. 100" WIDE DRIVE

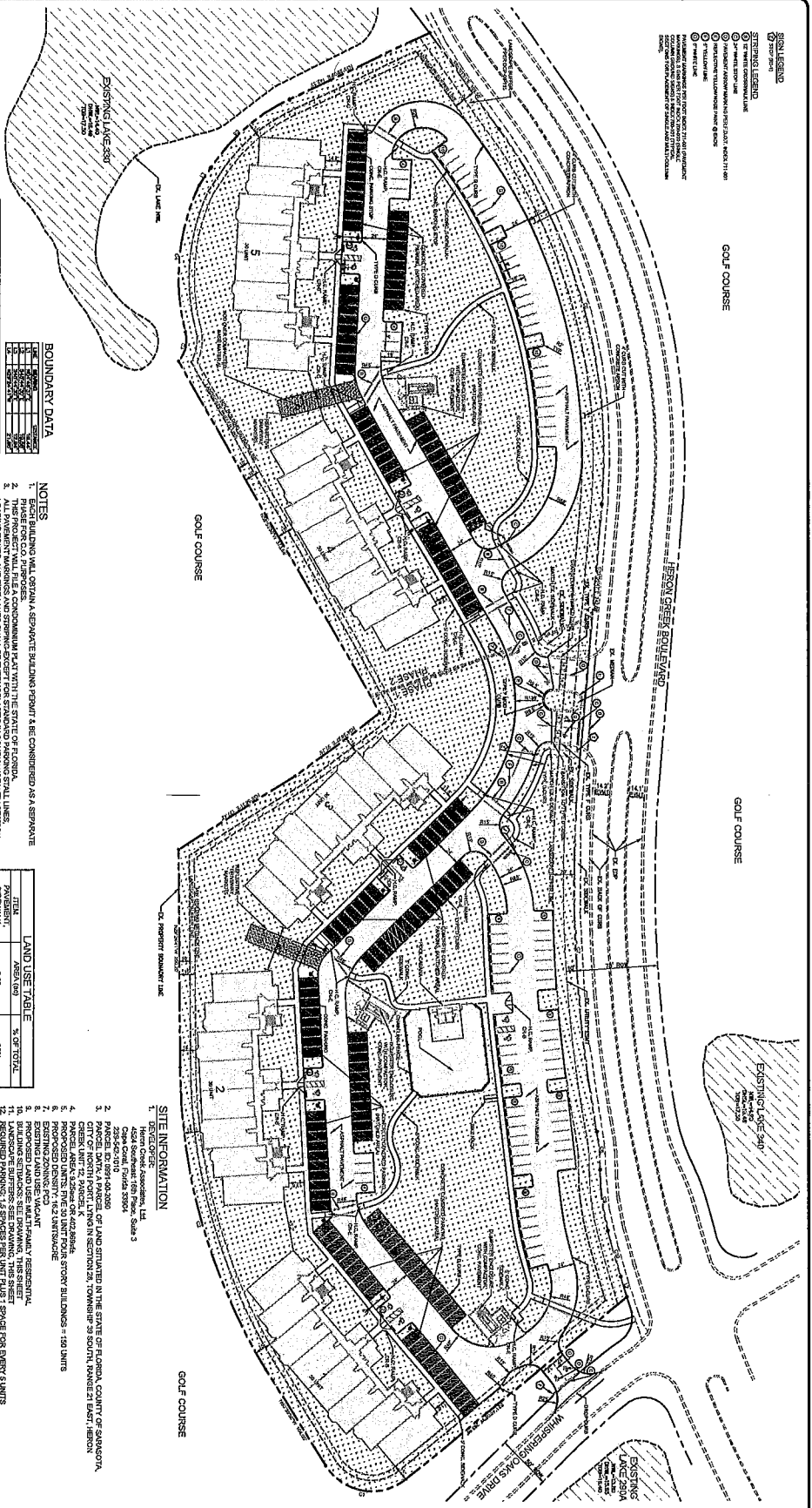

BOUNDARY DATA

NO.	DESCRIPTION	AREA (SQ. FT.)	PERCENT
1	EXISTING	1,234,567	100%
2	PROPOSED	1,234,567	100%

- NOTES**
1. EXISTING BUILDING WALL, OBTAIN A SEPARATE BUILDING REPORT & BE CONSIDERED AS A SEPARATE PHASE FOR C.O. PURPOSES.
 2. ALL PAVEMENT MARKINGS AND STRIPING EXCEPT FOR STANDARD PARKING SHALL BE AS SHOWN.
 3. ALL PAVEMENT MARKINGS AND STRIPING EXCEPT FOR STANDARD PARKING SHALL BE AS SHOWN.
 4. ALL PAVEMENT MARKINGS AND STRIPING EXCEPT FOR STANDARD PARKING SHALL BE AS SHOWN.
 5. ALL PAVEMENT MARKINGS AND STRIPING EXCEPT FOR STANDARD PARKING SHALL BE AS SHOWN.
 6. ALL PAVEMENT MARKINGS AND STRIPING EXCEPT FOR STANDARD PARKING SHALL BE AS SHOWN.
 7. ALL PAVEMENT MARKINGS AND STRIPING EXCEPT FOR STANDARD PARKING SHALL BE AS SHOWN.
 8. ALL PAVEMENT MARKINGS AND STRIPING EXCEPT FOR STANDARD PARKING SHALL BE AS SHOWN.
 9. ALL PAVEMENT MARKINGS AND STRIPING EXCEPT FOR STANDARD PARKING SHALL BE AS SHOWN.
 10. ALL PAVEMENT MARKINGS AND STRIPING EXCEPT FOR STANDARD PARKING SHALL BE AS SHOWN.
 11. ALL PAVEMENT MARKINGS AND STRIPING EXCEPT FOR STANDARD PARKING SHALL BE AS SHOWN.
 12. ALL PAVEMENT MARKINGS AND STRIPING EXCEPT FOR STANDARD PARKING SHALL BE AS SHOWN.
 13. ALL PAVEMENT MARKINGS AND STRIPING EXCEPT FOR STANDARD PARKING SHALL BE AS SHOWN.
 14. ALL PAVEMENT MARKINGS AND STRIPING EXCEPT FOR STANDARD PARKING SHALL BE AS SHOWN.
 15. ALL PAVEMENT MARKINGS AND STRIPING EXCEPT FOR STANDARD PARKING SHALL BE AS SHOWN.
 16. ALL PAVEMENT MARKINGS AND STRIPING EXCEPT FOR STANDARD PARKING SHALL BE AS SHOWN.
 17. ALL PAVEMENT MARKINGS AND STRIPING EXCEPT FOR STANDARD PARKING SHALL BE AS SHOWN.
 18. ALL PAVEMENT MARKINGS AND STRIPING EXCEPT FOR STANDARD PARKING SHALL BE AS SHOWN.
 19. ALL PAVEMENT MARKINGS AND STRIPING EXCEPT FOR STANDARD PARKING SHALL BE AS SHOWN.
 20. ALL PAVEMENT MARKINGS AND STRIPING EXCEPT FOR STANDARD PARKING SHALL BE AS SHOWN.
 21. ALL PAVEMENT MARKINGS AND STRIPING EXCEPT FOR STANDARD PARKING SHALL BE AS SHOWN.
 22. ALL PAVEMENT MARKINGS AND STRIPING EXCEPT FOR STANDARD PARKING SHALL BE AS SHOWN.
 23. ALL PAVEMENT MARKINGS AND STRIPING EXCEPT FOR STANDARD PARKING SHALL BE AS SHOWN.
 24. ALL PAVEMENT MARKINGS AND STRIPING EXCEPT FOR STANDARD PARKING SHALL BE AS SHOWN.
 25. ALL PAVEMENT MARKINGS AND STRIPING EXCEPT FOR STANDARD PARKING SHALL BE AS SHOWN.
 26. ALL PAVEMENT MARKINGS AND STRIPING EXCEPT FOR STANDARD PARKING SHALL BE AS SHOWN.
 27. ALL PAVEMENT MARKINGS AND STRIPING EXCEPT FOR STANDARD PARKING SHALL BE AS SHOWN.
 28. ALL PAVEMENT MARKINGS AND STRIPING EXCEPT FOR STANDARD PARKING SHALL BE AS SHOWN.
 29. ALL PAVEMENT MARKINGS AND STRIPING EXCEPT FOR STANDARD PARKING SHALL BE AS SHOWN.
 30. ALL PAVEMENT MARKINGS AND STRIPING EXCEPT FOR STANDARD PARKING SHALL BE AS SHOWN.
 31. ALL PAVEMENT MARKINGS AND STRIPING EXCEPT FOR STANDARD PARKING SHALL BE AS SHOWN.
 32. ALL PAVEMENT MARKINGS AND STRIPING EXCEPT FOR STANDARD PARKING SHALL BE AS SHOWN.
 33. ALL PAVEMENT MARKINGS AND STRIPING EXCEPT FOR STANDARD PARKING SHALL BE AS SHOWN.
 34. ALL PAVEMENT MARKINGS AND STRIPING EXCEPT FOR STANDARD PARKING SHALL BE AS SHOWN.
 35. ALL PAVEMENT MARKINGS AND STRIPING EXCEPT FOR STANDARD PARKING SHALL BE AS SHOWN.
 36. ALL PAVEMENT MARKINGS AND STRIPING EXCEPT FOR STANDARD PARKING SHALL BE AS SHOWN.
 37. ALL PAVEMENT MARKINGS AND STRIPING EXCEPT FOR STANDARD PARKING SHALL BE AS SHOWN.
 38. ALL PAVEMENT MARKINGS AND STRIPING EXCEPT FOR STANDARD PARKING SHALL BE AS SHOWN.
 39. ALL PAVEMENT MARKINGS AND STRIPING EXCEPT FOR STANDARD PARKING SHALL BE AS SHOWN.
 40. ALL PAVEMENT MARKINGS AND STRIPING EXCEPT FOR STANDARD PARKING SHALL BE AS SHOWN.
 41. ALL PAVEMENT MARKINGS AND STRIPING EXCEPT FOR STANDARD PARKING SHALL BE AS SHOWN.
 42. ALL PAVEMENT MARKINGS AND STRIPING EXCEPT FOR STANDARD PARKING SHALL BE AS SHOWN.
 43. ALL PAVEMENT MARKINGS AND STRIPING EXCEPT FOR STANDARD PARKING SHALL BE AS SHOWN.
 44. ALL PAVEMENT MARKINGS AND STRIPING EXCEPT FOR STANDARD PARKING SHALL BE AS SHOWN.
 45. ALL PAVEMENT MARKINGS AND STRIPING EXCEPT FOR STANDARD PARKING SHALL BE AS SHOWN.
 46. ALL PAVEMENT MARKINGS AND STRIPING EXCEPT FOR STANDARD PARKING SHALL BE AS SHOWN.
 47. ALL PAVEMENT MARKINGS AND STRIPING EXCEPT FOR STANDARD PARKING SHALL BE AS SHOWN.
 48. ALL PAVEMENT MARKINGS AND STRIPING EXCEPT FOR STANDARD PARKING SHALL BE AS SHOWN.
 49. ALL PAVEMENT MARKINGS AND STRIPING EXCEPT FOR STANDARD PARKING SHALL BE AS SHOWN.
 50. ALL PAVEMENT MARKINGS AND STRIPING EXCEPT FOR STANDARD PARKING SHALL BE AS SHOWN.

LAND USE TABLE

ITEM	LAND USE TABLE	% OF TOTAL
1. PAVEMENT	308	30%
2. BUILDINGS	158	17%
3. OPEN SPACE	461	50%
4. TOTAL SITE	927	100%

- SITE INFORMATION**
1. DEVELOPER: Heron Creek Associates, Ltd.
 2. PROJECT: 100-00-000 OF LAND SITUATED IN THE STATE OF FLORIDA, COUNTY OF SARASOTA, CITY OF NORTH PORT, LOTS 1, 2, 3, 4, 5, 6, 7, 8, 9, 10, 11, 12, 13, 14, 15, 16, 17, 18, 19, 20, 21, 22, 23, 24, 25, 26, 27, 28, 29, 30, 31, 32, 33, 34, 35, 36, 37, 38, 39, 40, 41, 42, 43, 44, 45, 46, 47, 48, 49, 50, 51, 52, 53, 54, 55, 56, 57, 58, 59, 60, 61, 62, 63, 64, 65, 66, 67, 68, 69, 70, 71, 72, 73, 74, 75, 76, 77, 78, 79, 80, 81, 82, 83, 84, 85, 86, 87, 88, 89, 90, 91, 92, 93, 94, 95, 96, 97, 98, 99, 100.
 3. PROJECT: 100-00-000 OF LAND SITUATED IN THE STATE OF FLORIDA, COUNTY OF SARASOTA, CITY OF NORTH PORT, LOTS 1, 2, 3, 4, 5, 6, 7, 8, 9, 10, 11, 12, 13, 14, 15, 16, 17, 18, 19, 20, 21, 22, 23, 24, 25, 26, 27, 28, 29, 30, 31, 32, 33, 34, 35, 36, 37, 38, 39, 40, 41, 42, 43, 44, 45, 46, 47, 48, 49, 50, 51, 52, 53, 54, 55, 56, 57, 58, 59, 60, 61, 62, 63, 64, 65, 66, 67, 68, 69, 70, 71, 72, 73, 74, 75, 76, 77, 78, 79, 80, 81, 82, 83, 84, 85, 86, 87, 88, 89, 90, 91, 92, 93, 94, 95, 96, 97, 98, 99, 100.
 4. PROJECT: 100-00-000 OF LAND SITUATED IN THE STATE OF FLORIDA, COUNTY OF SARASOTA, CITY OF NORTH PORT, LOTS 1, 2, 3, 4, 5, 6, 7, 8, 9, 10, 11, 12, 13, 14, 15, 16, 17, 18, 19, 20, 21, 22, 23, 24, 25, 26, 27, 28, 29, 30, 31, 32, 33, 34, 35, 36, 37, 38, 39, 40, 41, 42, 43, 44, 45, 46, 47, 48, 49, 50, 51, 52, 53, 54, 55, 56, 57, 58, 59, 60, 61, 62, 63, 64, 65, 66, 67, 68, 69, 70, 71, 72, 73, 74, 75, 76, 77, 78, 79, 80, 81, 82, 83, 84, 85, 86, 87, 88, 89, 90, 91, 92, 93, 94, 95, 96, 97, 98, 99, 100.
 5. PROJECT: 100-00-000 OF LAND SITUATED IN THE STATE OF FLORIDA, COUNTY OF SARASOTA, CITY OF NORTH PORT, LOTS 1, 2, 3, 4, 5, 6, 7, 8, 9, 10, 11, 12, 13, 14, 15, 16, 17, 18, 19, 20, 21, 22, 23, 24, 25, 26, 27, 28, 29, 30, 31, 32, 33, 34, 35, 36, 37, 38, 39, 40, 41, 42, 43, 44, 45, 46, 47, 48, 49, 50, 51, 52, 53, 54, 55, 56, 57, 58, 59, 60, 61, 62, 63, 64, 65, 66, 67, 68, 69, 70, 71, 72, 73, 74, 75, 76, 77, 78, 79, 80, 81, 82, 83, 84, 85, 86, 87, 88, 89, 90, 91, 92, 93, 94, 95, 96, 97, 98, 99, 100.
 6. PROJECT: 100-00-000 OF LAND SITUATED IN THE STATE OF FLORIDA, COUNTY OF SARASOTA, CITY OF NORTH PORT, LOTS 1, 2, 3, 4, 5, 6, 7, 8, 9, 10, 11, 12, 13, 14, 15, 16, 17, 18, 19, 20, 21, 22, 23, 24, 25, 26, 27, 28, 29, 30, 31, 32, 33, 34, 35, 36, 37, 38, 39, 40, 41, 42, 43, 44, 45, 46, 47, 48, 49, 50, 51, 52, 53, 54, 55, 56, 57, 58, 59, 60, 61, 62, 63, 64, 65, 66, 67, 68, 69, 70, 71, 72, 73, 74, 75, 76, 77, 78, 79, 80, 81, 82, 83, 84, 85, 86, 87, 88, 89, 90, 91, 92, 93, 94, 95, 96, 97, 98, 99, 100.
 7. PROJECT: 100-00-000 OF LAND SITUATED IN THE STATE OF FLORIDA, COUNTY OF SARASOTA, CITY OF NORTH PORT, LOTS 1, 2, 3, 4, 5, 6, 7, 8, 9, 10, 11, 12, 13, 14, 15, 16, 17, 18, 19, 20, 21, 22, 23, 24, 25, 26, 27, 28, 29, 30, 31, 32, 33, 34, 35, 36, 37, 38, 39, 40, 41, 42, 43, 44, 45, 46, 47, 48, 49, 50, 51, 52, 53, 54, 55, 56, 57, 58, 59, 60, 61, 62, 63, 64, 65, 66, 67, 68, 69, 70, 71, 72, 73, 74, 75, 76, 77, 78, 79, 80, 81, 82, 83, 84, 85, 86, 87, 88, 89, 90, 91, 92, 93, 94, 95, 96, 97, 98, 99, 100.
 8. PROJECT: 100-00-000 OF LAND SITUATED IN THE STATE OF FLORIDA, COUNTY OF SARASOTA, CITY OF NORTH PORT, LOTS 1, 2, 3, 4, 5, 6, 7, 8, 9, 10, 11, 12, 13, 14, 15, 16, 17, 18, 19, 20, 21, 22, 23, 24, 25, 26, 27, 28, 29, 30, 31, 32, 33, 34, 35, 36, 37, 38, 39, 40, 41, 42, 43, 44, 45, 46, 47, 48, 49, 50, 51, 52, 53, 54, 55, 56, 57, 58, 59, 60, 61, 62, 63, 64, 65, 66, 67, 68, 69, 70, 71, 72, 73, 74, 75, 76, 77, 78, 79, 80, 81, 82, 83, 84, 85, 86, 87, 88, 89, 90, 91, 92, 93, 94, 95, 96, 97, 98, 99, 100.
 9. PROJECT: 100-00-000 OF LAND SITUATED IN THE STATE OF FLORIDA, COUNTY OF SARASOTA, CITY OF NORTH PORT, LOTS 1, 2, 3, 4, 5, 6, 7, 8, 9, 10, 11, 12, 13, 14, 15, 16, 17, 18, 19, 20, 21, 22, 23, 24, 25, 26, 27, 28, 29, 30, 31, 32, 33, 34, 35, 36, 37, 38, 39, 40, 41, 42, 43, 44, 45, 46, 47, 48, 49, 50, 51, 52, 53, 54, 55, 56, 57, 58, 59, 60, 61, 62, 63, 64, 65, 66, 67, 68, 69, 70, 71, 72, 73, 74, 75, 76, 77, 78, 79, 80, 81, 82, 83, 84, 85, 86, 87, 88, 89, 90, 91, 92, 93, 94, 95, 96, 97, 98, 99, 100.
 10. PROJECT: 100-00-000 OF LAND SITUATED IN THE STATE OF FLORIDA, COUNTY OF SARASOTA, CITY OF NORTH PORT, LOTS 1, 2, 3, 4, 5, 6, 7, 8, 9, 10, 11, 12, 13, 14, 15, 16, 17, 18, 19, 20, 21, 22, 23, 24, 25, 26, 27, 28, 29, 30, 31, 32, 33, 34, 35, 36, 37, 38, 39, 40, 41, 42, 43, 44, 45, 46, 47, 48, 49, 50, 51, 52, 53, 54, 55, 56, 57, 58, 59, 60, 61, 62, 63, 64, 65, 66, 67, 68, 69, 70, 71, 72, 73, 74, 75, 76, 77, 78, 79, 80, 81, 82, 83, 84, 85, 86, 87, 88, 89, 90, 91, 92, 93, 94, 95, 96, 97, 98, 99, 100.
 11. PROJECT: 100-00-000 OF LAND SITUATED IN THE STATE OF FLORIDA, COUNTY OF SARASOTA, CITY OF NORTH PORT, LOTS 1, 2, 3, 4, 5, 6, 7, 8, 9, 10, 11, 12, 13, 14, 15, 16, 17, 18, 19, 20, 21, 22, 23, 24, 25, 26, 27, 28, 29, 30, 31, 32, 33, 34, 35, 36, 37, 38, 39, 40, 41, 42, 43, 44, 45, 46, 47, 48, 49, 50, 51, 52, 53, 54, 55, 56, 57, 58, 59, 60, 61, 62, 63, 64, 65, 66, 67, 68, 69, 70, 71, 72, 73, 74, 75, 76, 77, 78, 79, 80, 81, 82, 83, 84, 85, 86, 87, 88, 89, 90, 91, 92, 93, 94, 95, 96, 97, 98, 99, 100.
 12. PROJECT: 100-00-000 OF LAND SITUATED IN THE STATE OF FLORIDA, COUNTY OF SARASOTA, CITY OF NORTH PORT, LOTS 1, 2, 3, 4, 5, 6, 7, 8, 9, 10, 11, 12, 13, 14, 15, 16, 17, 18, 19, 20, 21, 22, 23, 24, 25, 26, 27, 28, 29, 30, 31, 32, 33, 34, 35, 36, 37, 38, 39, 40, 41, 42, 43, 44, 45, 46, 47, 48, 49, 50, 51, 52, 53, 54, 55, 56, 57, 58, 59, 60, 61, 62, 63, 64, 65, 66, 67, 68, 69, 70, 71, 72, 73, 74, 75, 76, 77, 78, 79, 80, 81, 82, 83, 84, 85, 86, 87, 88, 89, 90, 91, 92, 93, 94, 95, 96, 97, 98, 99, 100.
 13. PROJECT: 100-00-000 OF LAND SITUATED IN THE STATE OF FLORIDA, COUNTY OF SARASOTA, CITY OF NORTH PORT, LOTS 1, 2, 3, 4, 5, 6, 7, 8, 9, 10, 11, 12, 13, 14, 15, 16, 17, 18, 19, 20, 21, 22, 23, 24, 25, 26, 27, 28, 29, 30, 31, 32, 33, 34, 35, 36, 37, 38, 39, 40, 41, 42, 43, 44, 45, 46, 47, 48, 49, 50, 51, 52, 53, 54, 55, 56, 57, 58, 59, 60, 61, 62, 63, 64, 65, 66, 67, 68, 69, 70, 71, 72, 73, 74, 75, 76, 77, 78, 79, 80, 81, 82, 83, 84, 85, 86, 87, 88, 89, 90, 91, 92, 93, 94, 95, 96, 97, 98, 99, 100.
 14. PROJECT: 100-00-000 OF LAND SITUATED IN THE STATE OF FLORIDA, COUNTY OF SARASOTA, CITY OF NORTH PORT, LOTS 1, 2, 3, 4, 5, 6, 7, 8, 9, 10, 11, 12, 13, 14, 15, 16, 17, 18, 19, 20, 21, 22, 23, 24, 25, 26, 27, 28, 29, 30, 31, 32, 33, 34, 35, 36, 37, 38, 39, 40, 41, 42, 43, 44, 45, 46, 47, 48, 49, 50, 51, 52, 53, 54, 55, 56, 57, 58, 59, 60, 61, 62, 63, 64, 65, 66, 67, 68, 69, 70, 71, 72, 73, 74, 75, 76, 77, 78, 79, 80, 81, 82, 83, 84, 85, 86, 87, 88, 89, 90, 91, 92, 93, 94, 95, 96, 97, 98, 99, 100.
 15. PROJECT: 100-00-000 OF LAND SITUATED IN THE STATE OF FLORIDA, COUNTY OF SARASOTA, CITY OF NORTH PORT, LOTS 1, 2, 3, 4, 5, 6, 7, 8, 9, 10, 11, 12, 13, 14, 15, 16, 17, 18, 19, 20, 21, 22, 23, 24, 25, 26, 27, 28, 29, 30, 31, 32, 33, 34, 35, 36, 37, 38, 39, 40, 41, 42, 43, 44, 45, 46, 47, 48, 49, 50, 51, 52, 53, 54, 55, 56, 57, 58, 59, 60, 61, 62, 63, 64, 65, 66, 67, 68, 69, 70, 71, 72, 73, 74, 75, 76, 77, 78, 79, 80, 81, 82, 83, 84, 85, 86, 87, 88, 89, 90, 91, 92, 93, 94, 95, 96, 97, 98, 99, 100.
 16. PROJECT: 100-00-000 OF LAND SITUATED IN THE STATE OF FLORIDA, COUNTY OF SARASOTA, CITY OF NORTH PORT, LOTS 1, 2, 3, 4, 5, 6, 7, 8, 9, 10, 11, 12, 13, 14, 15, 16, 17, 18, 19, 20, 21, 22, 23, 24, 25, 26, 27, 28, 29, 30, 31, 32, 33, 34, 35, 36, 37, 38, 39, 40, 41, 42, 43, 44, 45, 46, 47, 48, 49, 50, 51, 52, 53, 54, 55, 56, 57, 58, 59, 60, 61, 62, 63, 64, 65, 66, 67, 68, 69, 70, 71, 72, 73, 74, 75, 76, 77, 78, 79, 80, 81, 82, 83, 84, 85, 86, 87, 88, 89, 90, 91, 92, 93, 94, 95, 96, 97, 98, 99, 100.
 17. PROJECT: 100-00-000 OF LAND SITUATED IN THE STATE OF FLORIDA, COUNTY OF SARASOTA, CITY OF NORTH PORT, LOTS 1, 2, 3, 4, 5, 6, 7, 8, 9, 10, 11, 12, 13, 14, 15, 16, 17, 18, 19, 20, 21, 22, 23, 24, 25, 26, 27, 28, 29, 30, 31, 32, 33, 34, 35, 36, 37, 38, 39, 40, 41, 42, 43, 44, 45, 46, 47, 48, 49, 50, 51, 52, 53, 54, 55, 56, 57, 58, 59, 60, 61, 62, 63, 64, 65, 66, 67, 68, 69, 70, 71, 72, 73, 74, 75, 76, 77, 78, 79, 80, 81, 82, 83, 84, 85, 86, 87, 88, 89, 90, 91, 92, 93, 94, 95, 96, 97, 98, 99, 100.

HERON CREEK ASSOCIATES, LTD.
 10000 N. W. 11th St., Suite 100
 Fort Lauderdale, FL 33309
 Phone: (954) 575-1100
 Fax: (954) 575-1101
 Website: www.heron-creek.com

MORRIS ENGINEERING AND CONSULTING, LLC
 10000 N. W. 11th St., Suite 100
 Fort Lauderdale, FL 33309
 Phone: (954) 575-1100
 Fax: (954) 575-1101
 Website: www.morris-engineering.com

MASTER SITE PLAN
HERON CREEK - PARCEL K
 NORTH PORT, FLORIDA

DATE: 11/11/11
SCALE: AS SHOWN
SHEET: 5
OF: 11

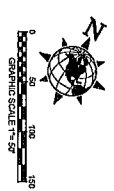

Heron Creek Associates, Ltd.
 4250 Central Expressway, Suite 4
 Orlando, Florida 32817
 (407) 253-0000

M
MORRIS ENGINEERING AND CONSULTING, LLC
 Civil Engineering and Land Development Consulting
 3801 Lake Nona Boulevard, Suite 1000
 Orlando, Florida 32817
 (407) 253-0000

NO.	DATE	DESCRIPTION
1	01/15/08	PRELIMINARY PLAN
2	02/15/08	REVISED PLAN
3	03/15/08	REVISED PLAN
4	04/15/08	REVISED PLAN
5	05/15/08	REVISED PLAN
6	06/15/08	REVISED PLAN

GRADING & DRAINAGE PLAN
HERON CREEK - PARCEL K
 NORTH PORT, FLORIDA

SHEET
6
 OF
 11

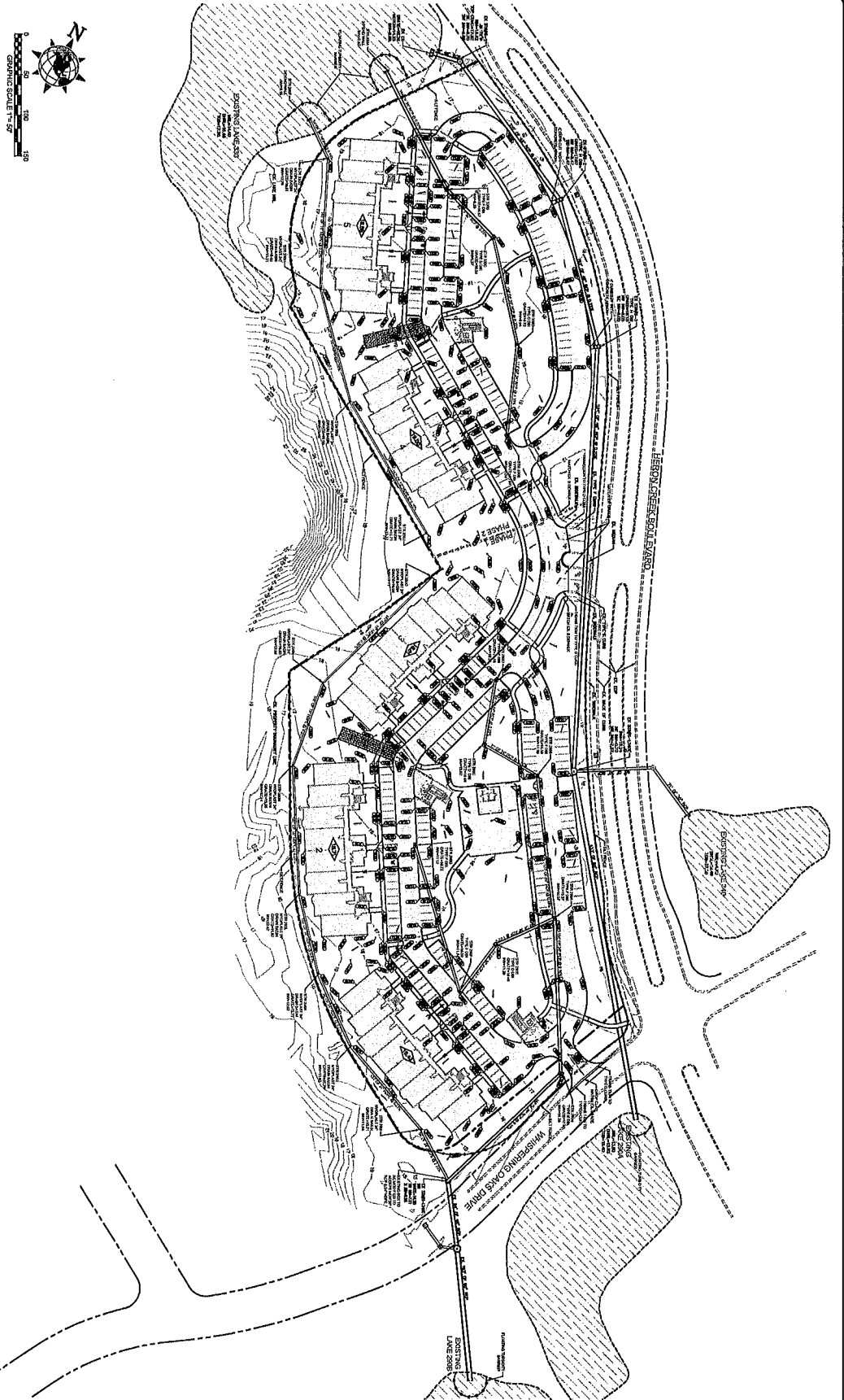

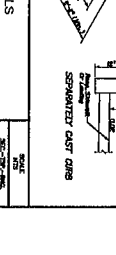
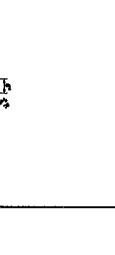
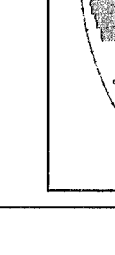
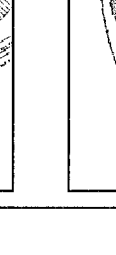
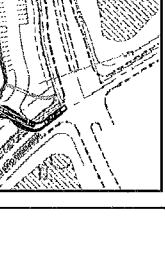
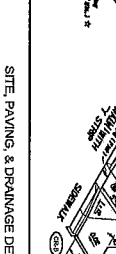
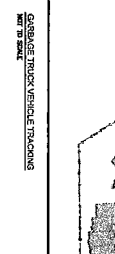
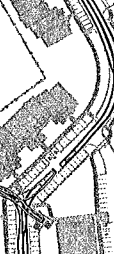
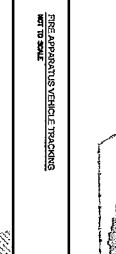
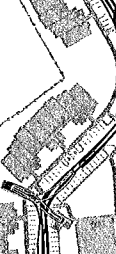
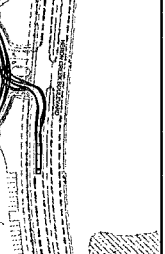
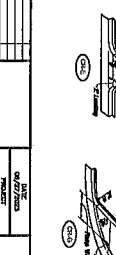
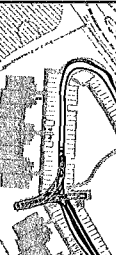
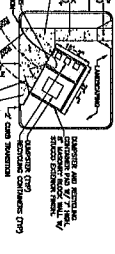
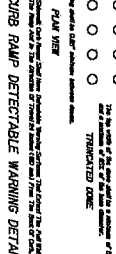
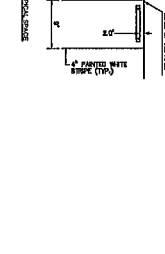
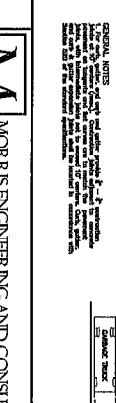
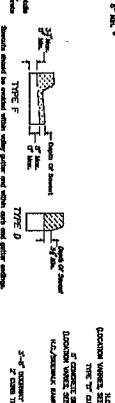
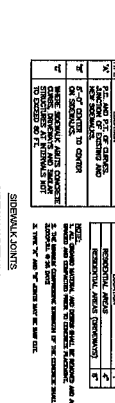
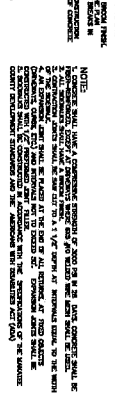
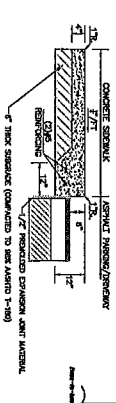
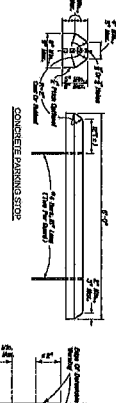
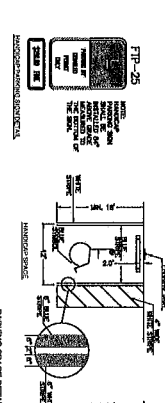
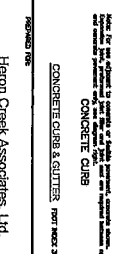
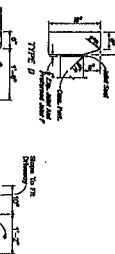
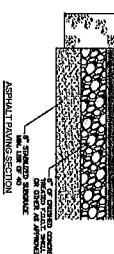
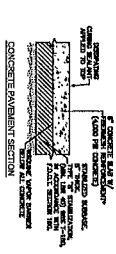
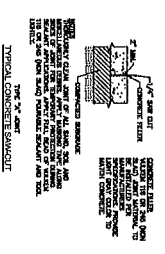

HEAVY 108
 Heaton Creek Associates, Ltd.
 10800 South 10th Avenue, Suite 200
 Fort Lauderdale, Florida 33325
 (305) 467-1080
MORRIS ENGINEERING AND CONSULTING, LLC
 Civil Engineering and Land Development Consulting
 10000 North 15th Avenue, Suite 100
 Fort Lauderdale, Florida 33325
 (305) 467-1080
HEAVY 108
 SHEET NO. 8 OF 11
 SITE PAVING & DRAINAGE DETAILS
 HERON CREEK - PARCEL K
 NORTH PORT, FLORIDA

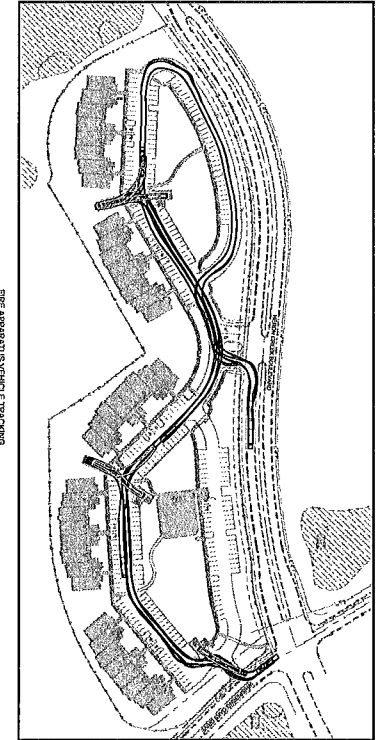
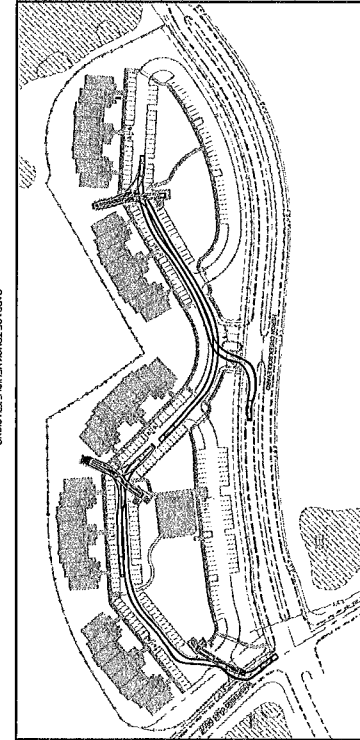

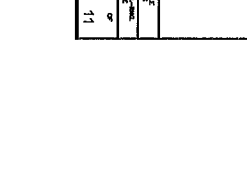
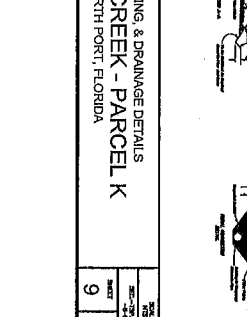
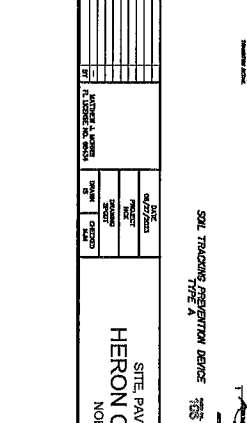
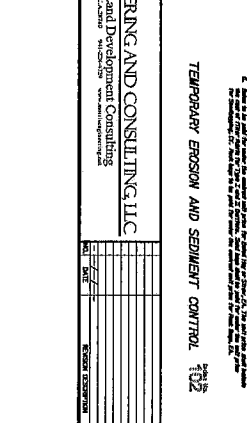
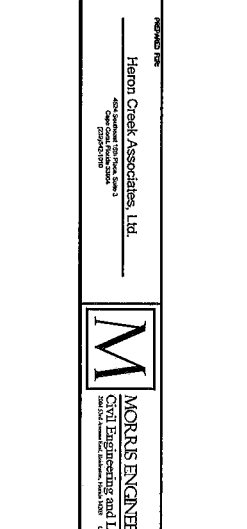
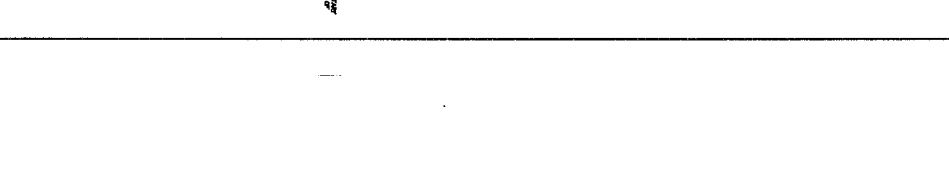
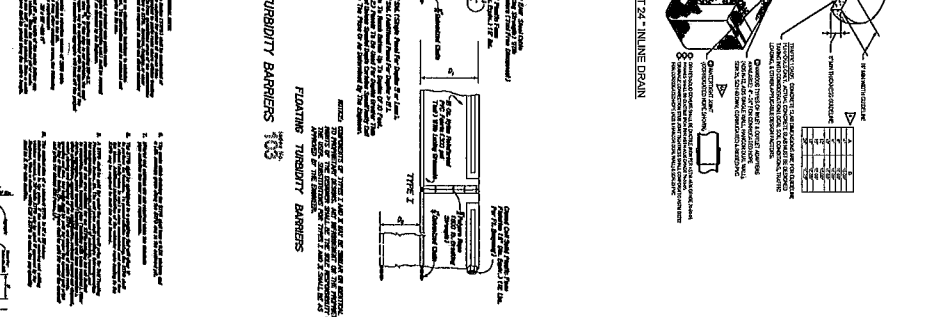
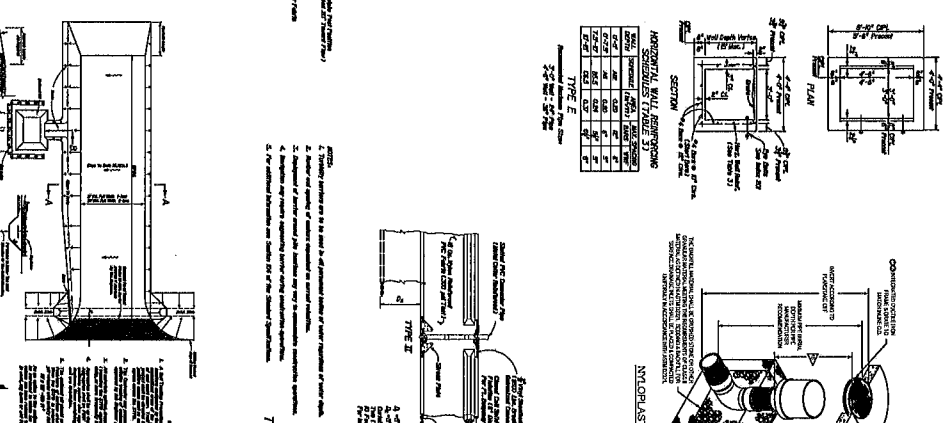
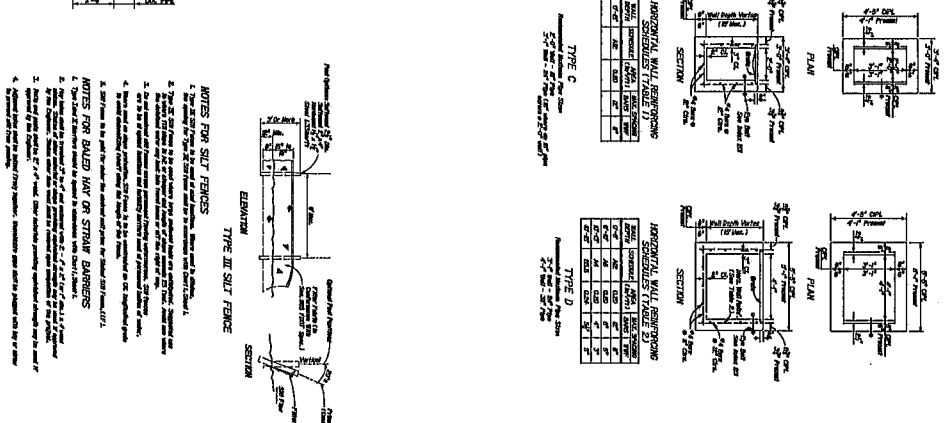
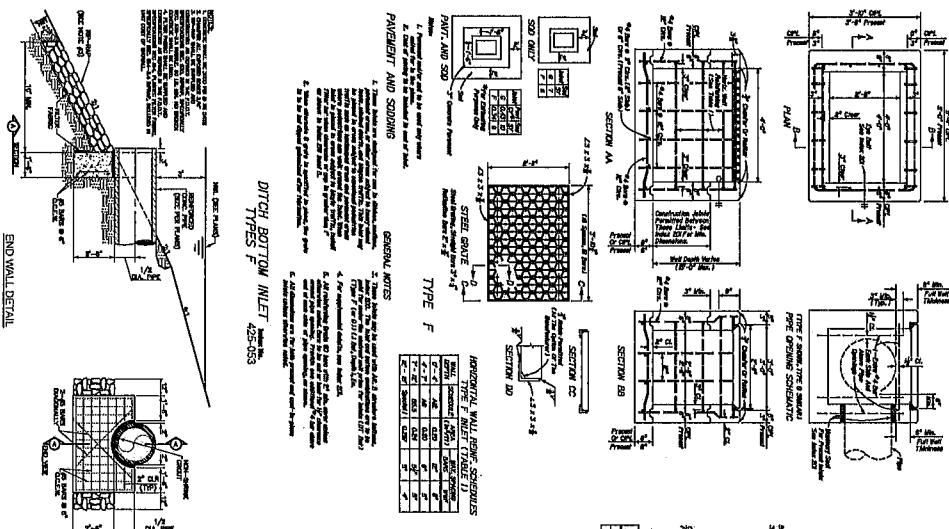

NOTES FOR SILT FENCES

1. The silt fence shall be constructed in accordance with the specifications for Silt Fences, ACI 308R-03.
2. The silt fence shall be constructed in accordance with the specifications for Silt Fences, ACI 308R-03.
3. The silt fence shall be constructed in accordance with the specifications for Silt Fences, ACI 308R-03.
4. The silt fence shall be constructed in accordance with the specifications for Silt Fences, ACI 308R-03.
5. The silt fence shall be constructed in accordance with the specifications for Silt Fences, ACI 308R-03.
6. The silt fence shall be constructed in accordance with the specifications for Silt Fences, ACI 308R-03.

NOTES FOR MAILED WIRE OR STRAP BARRIERS

1. The barrier shall be constructed in accordance with the specifications for Mailed Wire or Strap Barriers, ACI 308R-03.
2. The barrier shall be constructed in accordance with the specifications for Mailed Wire or Strap Barriers, ACI 308R-03.
3. The barrier shall be constructed in accordance with the specifications for Mailed Wire or Strap Barriers, ACI 308R-03.
4. The barrier shall be constructed in accordance with the specifications for Mailed Wire or Strap Barriers, ACI 308R-03.
5. The barrier shall be constructed in accordance with the specifications for Mailed Wire or Strap Barriers, ACI 308R-03.
6. The barrier shall be constructed in accordance with the specifications for Mailed Wire or Strap Barriers, ACI 308R-03.

NOTES FOR TURBIDITY BARRIERS

1. The barrier shall be constructed in accordance with the specifications for Turbidity Barriers, ACI 308R-03.
2. The barrier shall be constructed in accordance with the specifications for Turbidity Barriers, ACI 308R-03.
3. The barrier shall be constructed in accordance with the specifications for Turbidity Barriers, ACI 308R-03.
4. The barrier shall be constructed in accordance with the specifications for Turbidity Barriers, ACI 308R-03.
5. The barrier shall be constructed in accordance with the specifications for Turbidity Barriers, ACI 308R-03.
6. The barrier shall be constructed in accordance with the specifications for Turbidity Barriers, ACI 308R-03.

NOTES FOR SOIL TRACKING PREVENTION DEVICE

1. The device shall be constructed in accordance with the specifications for Soil Tracking Prevention Devices, ACI 308R-03.
2. The device shall be constructed in accordance with the specifications for Soil Tracking Prevention Devices, ACI 308R-03.
3. The device shall be constructed in accordance with the specifications for Soil Tracking Prevention Devices, ACI 308R-03.
4. The device shall be constructed in accordance with the specifications for Soil Tracking Prevention Devices, ACI 308R-03.
5. The device shall be constructed in accordance with the specifications for Soil Tracking Prevention Devices, ACI 308R-03.
6. The device shall be constructed in accordance with the specifications for Soil Tracking Prevention Devices, ACI 308R-03.

NO.	REVISION	DATE	BY	CHKD.
1	ISSUED FOR PERMIT	08/15/08	MM	MM
2	REVISED PER COMMENTS	08/20/08	MM	MM
3	REVISED PER COMMENTS	09/02/08	MM	MM
4	REVISED PER COMMENTS	09/02/08	MM	MM
5	REVISED PER COMMENTS	09/02/08	MM	MM
6	REVISED PER COMMENTS	09/02/08	MM	MM
7	REVISED PER COMMENTS	09/02/08	MM	MM
8	REVISED PER COMMENTS	09/02/08	MM	MM
9	REVISED PER COMMENTS	09/02/08	MM	MM
10	REVISED PER COMMENTS	09/02/08	MM	MM
11	REVISED PER COMMENTS	09/02/08	MM	MM

REVISIONS FOR:

Heron Creek Associates, Ltd.

4600 Sandhill Road, Suite 100
Orlando, Florida 32837
Tel: 407.851.1100

MORIS ENGINEERING AND CONSULTING, LLC

1001 E. Bay Street, Suite 100
Orlando, Florida 32801
Tel: 407.851.1100

PROJECT INFORMATION

PROJECT NO. 08-001

CLIENT: MORIS ENGINEERING AND CONSULTING, LLC

DATE: 08/15/08

SCALE: AS SHOWN

SITE PAVING & DRAINAGE DETAILS

HERON CREEK - PARCEL K

NORTH PORT, FLORIDA

DATE: 08/15/08

BY: MM

CHKD.: MM

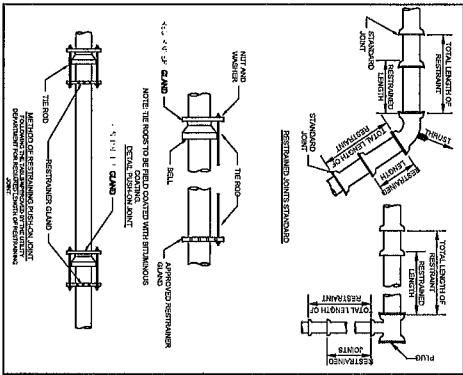

TABLE 1

MINIMUM RESTRAINT LENGTHS FOR RESTRAINTS TO BE USED IN ACCORDANCE WITH THESE SPECIFICATIONS

RESTRAINT TYPE	MIN. RESTRAINT LENGTH	MIN. RESTRAINT LENGTH	MIN. RESTRAINT LENGTH	MIN. RESTRAINT LENGTH
	IN	MM	IN	MM
1. RESTRAINTS TO BE USED IN ACCORDANCE WITH THESE SPECIFICATIONS	6	152	6	152
2. RESTRAINTS TO BE USED IN ACCORDANCE WITH THESE SPECIFICATIONS	6	152	6	152
3. RESTRAINTS TO BE USED IN ACCORDANCE WITH THESE SPECIFICATIONS	6	152	6	152
4. RESTRAINTS TO BE USED IN ACCORDANCE WITH THESE SPECIFICATIONS	6	152	6	152
5. RESTRAINTS TO BE USED IN ACCORDANCE WITH THESE SPECIFICATIONS	6	152	6	152
6. RESTRAINTS TO BE USED IN ACCORDANCE WITH THESE SPECIFICATIONS	6	152	6	152
7. RESTRAINTS TO BE USED IN ACCORDANCE WITH THESE SPECIFICATIONS	6	152	6	152
8. RESTRAINTS TO BE USED IN ACCORDANCE WITH THESE SPECIFICATIONS	6	152	6	152
9. RESTRAINTS TO BE USED IN ACCORDANCE WITH THESE SPECIFICATIONS	6	152	6	152
10. RESTRAINTS TO BE USED IN ACCORDANCE WITH THESE SPECIFICATIONS	6	152	6	152

TABLE 2

RESTRAINT CLAMP DIMENSIONS

RESTRAINT CLAMP TYPE	MIN. RESTRAINT LENGTH	MIN. RESTRAINT LENGTH	MIN. RESTRAINT LENGTH	MIN. RESTRAINT LENGTH
	IN	MM	IN	MM
1. RESTRAINT CLAMPS TO BE USED IN ACCORDANCE WITH THESE SPECIFICATIONS	6	152	6	152
2. RESTRAINT CLAMPS TO BE USED IN ACCORDANCE WITH THESE SPECIFICATIONS	6	152	6	152
3. RESTRAINT CLAMPS TO BE USED IN ACCORDANCE WITH THESE SPECIFICATIONS	6	152	6	152
4. RESTRAINT CLAMPS TO BE USED IN ACCORDANCE WITH THESE SPECIFICATIONS	6	152	6	152
5. RESTRAINT CLAMPS TO BE USED IN ACCORDANCE WITH THESE SPECIFICATIONS	6	152	6	152
6. RESTRAINT CLAMPS TO BE USED IN ACCORDANCE WITH THESE SPECIFICATIONS	6	152	6	152
7. RESTRAINT CLAMPS TO BE USED IN ACCORDANCE WITH THESE SPECIFICATIONS	6	152	6	152
8. RESTRAINT CLAMPS TO BE USED IN ACCORDANCE WITH THESE SPECIFICATIONS	6	152	6	152
9. RESTRAINT CLAMPS TO BE USED IN ACCORDANCE WITH THESE SPECIFICATIONS	6	152	6	152
10. RESTRAINT CLAMPS TO BE USED IN ACCORDANCE WITH THESE SPECIFICATIONS	6	152	6	152

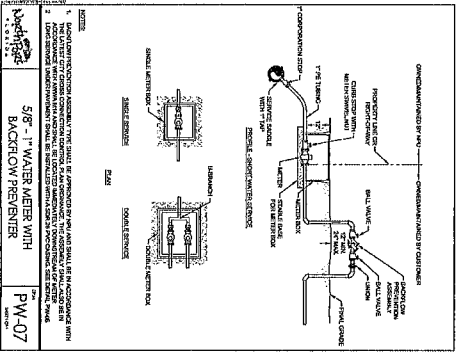
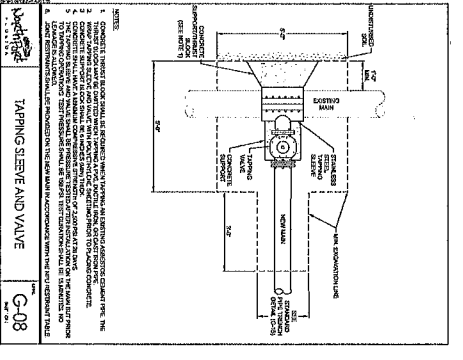
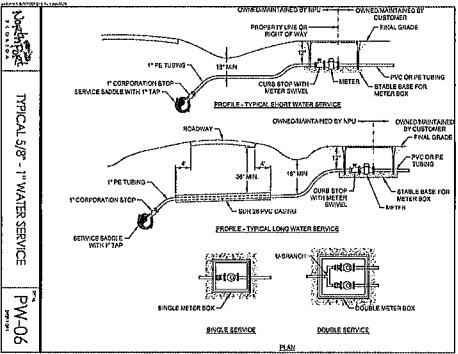
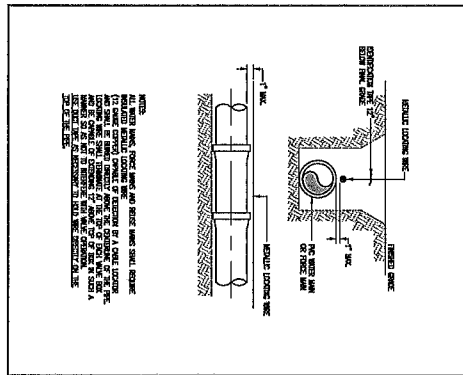
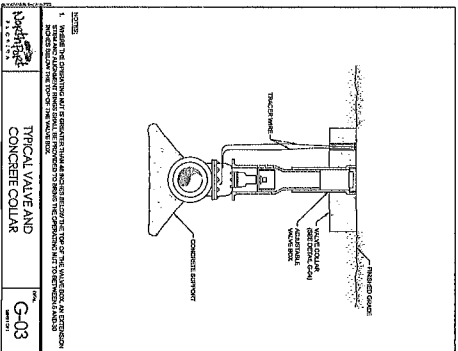
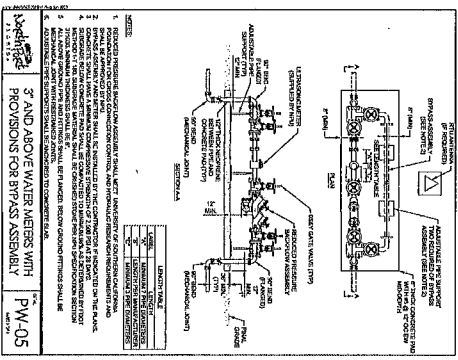

Heiron Creek Associates, Ltd.
4045 Sheppard Ave. East, Suite 3
Oscar Peterson Building
Toronto, Ontario M2N 6L2

M MORRIS ENGINEERING AND CONSULTING, LLC
Civil Engineering and Land Development Consulting
1500 West Beaver Creek Road, Suite 200
Richmond Hill, Ontario L4B 1M2

UTILITY DETAILS - POTABLE WATER
HERON CREEK - PARCEL K
NORTH PORT, FLORIDA

PW-05
PW-06
PW-07

RESTRAINT TABLE
TAPPING SLEEVE AND VALVE

10
11

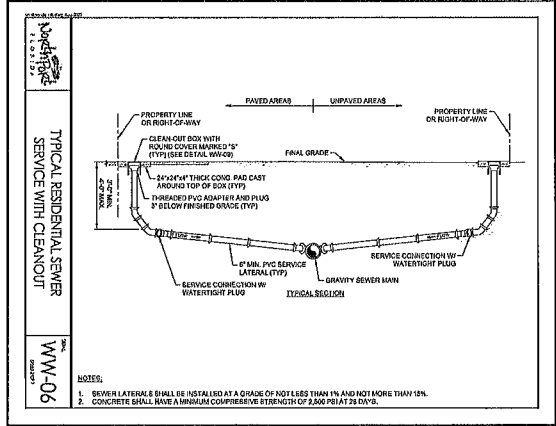
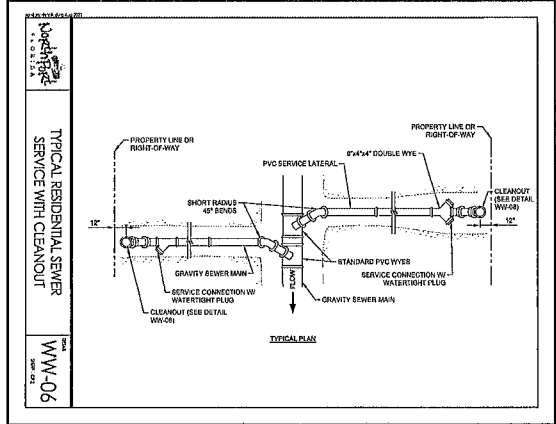
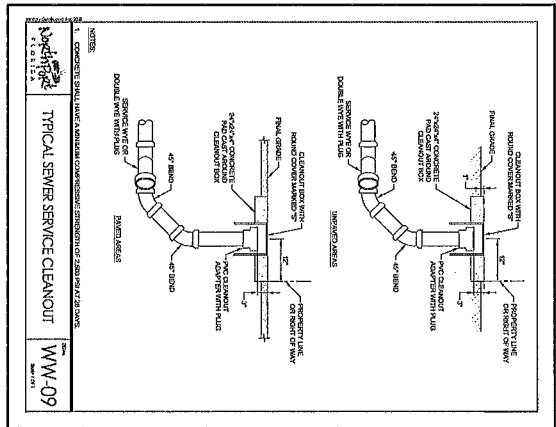
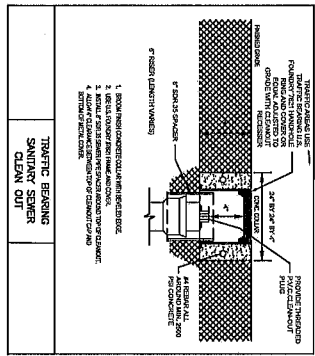

- NOTES:
- SEWER LATERALS SHALL BE INSTALLED AT A GRADE OF NOT LESS THAN 1% AND NOT MORE THAN 5%.
 - CONCRETE SHALL HAVE A MINIMUM COMPRESSIVE STRENGTH OF 2,500 PSI AT 28 DAYS.

PROJECT NO:
 Heron Creek Associates, Ltd.
 400 Sandhill Way, Suite 200
 Cape Canaveral, Florida 32926

M
 MORRIS ENGINEERING AND CONSULTING, LLC
 Civil, Environmental, and Land Development Consulting
 3815 W. U.S. Highway 1, Suite 200
 Cape Canaveral, Florida 32926

NO.	DATE	REVISION DESCRIPTION

UTILITY DETAILS - SANITARY SEWER
 HERON CREEK - PARCEL K
 NORTH PORT, FLORIDA

NO.	DATE	REVISION
11	11	11

Traffic Impact Statement
Heron Creek Unit 12 (Parcel K) – Heron Creek Boulevard

Based on the Institute of Transportation Engineers Trip Generation, 11th Edition, 2008.

Proposed Land Use: LUC 230 residential Condominium/Townhouse (150 Units)

- Average Vehicle Trip Ends on a weekday vs. dwelling units
150 Units *6.74 Trips/Unit = 1011 2-Way Trip Ends
entering = 50% = 506
exiting = 50% = 505

- Average Vehicle Trip Ends on a weekday, a.m. peak hour of generator vs. dwelling units
entering = 17 Right turn = 48% = 8 Left turn = 52% = 9
exiting = 54 Right turn = 52% = 28 Left turn = 48% = 26

- Average Vehicle Trip Ends on a weekday, p.m. peak hour of generator vs. dwelling units
entering = 53 Right turn = 48% = 25 Left turn = 52% = 28
exiting = 32 Right turn = 52% = 17 Left turn = 48% = 15

Traffic Mitigation Plan:

- Heron Creek Boulevard is classified as a private local roadway with a posted speed limit of 15 m.p.h. Traffic is controlled through stop signs and stop bars. Off-site impacts have been addressed through the Traffic portion of the Heron Creek D.R.I. Development Order.

- **Acceleration lane:**
Only required on high speed facilities which are posted 40 m.p.h. or more and which have a significant traffic volume. Since this is a low speed facility and a low traffic volume, an acceleration lane is not required.

- **Deceleration and left turn lane (local street):**
 - 1) The posted speed is less than 30 m.p.h. (15 m.p.h)
 - 2) There are less than 60 left turning vehicles from the two lane local street during a.m. or p.m. peak hour, there are less than 500 opposing through traffic during a.m. or p.m. peak hour.
 - 3) The available sight distance for a left turning vehicle or approaching vehicle is not less than the value 125' for the posted speed limit.
 - 4) Access control is not an applicable warrant in this case.
 - 5) Traffic control: The intersecting street or access point driveway is not controlled by a traffic signal (stop signs and stop bars are used).

Therefore, a deceleration and left turn lane is not required.

- **Separate left turn lane (local street):**

- 1) The posted speed limit is less than 30 m.p.h. (15 m.p.h.)
- 2) There are less than 90 left turning vehicles from the intersection street or access point driveway during either a.m. or p.m. peak hour
- 3) Available sight distance is not an applicable warrant in this case.
- 4) Access control is not an applicable warrant in this case.
- 5) There is not an intersecting street or access point driveway controlled by a traffic signal (stop signs and stop bars used).

Therefore, a separate left turn lane is not required.

- **Deceleration and right turn lane (local street):**

- 1) The posted speed limit is less than 30 m.p.h. (15 m.p.h.)
- 2) The number of right turning movements from the local street is less than 60 during either the a.m. or p.m. peak hour.
- 3) If the available sight distance for a right turning vehicle to be seen by through traffic traveling in the same direction is not less than 125'.
- 4) Access control is not an applicable warrant in this case.
- 5) There is no intersecting street or access point driveway controlled by a traffic signal (stop signs and stop bars used).

Therefore, a deceleration and right turn lane is not required.

- **Separate right turn lane (local street):**

- 1) The posted speed limit is less than 30 m.p.h. (15 m.p.h.)
- 2) The number of right turning vehicles from the access point driveway is less than 120 during either the a.m. or p.m. peak hour
- 3) Available sight distance is not an applicable warrant in this case.
- 4) Access control is not an applicable warrant in this case.
- 5) Traffic control
 - i) Intersecting street or access point driveway is not controlled by a traffic signal.
 - ii) An acceleration lane is not provided on the local street and the right turn movement is controlled by a yield or stop sign.

Therefore, a separate right turn lane is not required.

With regard to the left-turn lane, there is even less of an impact (15 additional north-bound left-turns), therefore we would propose that the current left turn lane is sufficient.

I certify that this Traffic Impact statement for Heron Creek Unit 12 (Parcel K) was prepared by me, or under my direct supervision.

From: Nicole Galehouse

Sent: Tuesday, March 17, 2020 4:55 PM

To: Ronald York <ron@nationallandgroup.net>; Jim Bevillard <jim@nationallandgroup.net>

Cc: Everett Farrell <efarrell@cityofnorthport.com>; Frank Miles <fmiles@cityofnorthport.com>; Jason Yarborough <jyarborough@cityofnorthport.com>; Peter Lear (plear@cityofnorthport.com) <plear@cityofnorthport.com>

Subject: Heron Creek Meeting Recap

Ron & Jim,

Thank you for coming in to meet with us today. I think it was great for us to sit down and go over what your plans are so we're all on the same page moving forward. I wanted to provide a brief recap of the meeting for follow-up purposes.

- The Assisted Living Facility is categorized under general office. You will provide us with an updated land use matrix for the project file to account for the adjustment in land uses. As I mentioned, I would encourage close communication with our engineering team to ensure that any changes in use do not exceed the original permitted number of trips for the DRI. I have attached both of their cards for your convenience.
- Planning will look for the original approvals related to Parcel K and determine a clear path to move forward with development of that project.
- In order to evaluate a potential reduction in number of holes on the course, Planning will run the fiscal impact model for 100 acres of golf course, multi-family, and single-family to see what the different impact is for each type.
- Planning will be submitting a legal request in relation to the uses on Map H for the SW quadrant of the project, with our attorney coordinating with yours for history. We will determine if the change can be identified as a scrivener's error or if it needs to be included in a DO change if multi-family is desired on that site.
- Planning is working with Building, Finance, and IT to run a report on total transportation impact fees paid within the development. Once you receive this, you will provide us with the 2016-2018 annual monitoring report.
- We discussed the scrub jay issue, and made you aware that Commission has directed enforcement of the original provisions. In our conversation, you indicated that the City was supposed to be a partner in the management of the habitat, and are going to look through your files for this documentation. You are also going to look into the boundaries further and potentially get the data that we can overlay on property lines or other GIS features.

As we discussed, the DRI with current extensions expires on September 28, 2021. The intention is to continue the DRI through to buildout. In order to achieve that, you will be preparing an NOPC (or other amendment if staff determines a different process applies) for submittal to the City in early 2021 unless any additional state of emergencies apply to extend the project further.

Please let me know if there is anything I missed. I will be reaching out to you on these items in the coming weeks. I look forward to working with you on the continued development and buildout of the DRI.

Nicole Galehouse, AICP
Planning Division Manager

Neighborhood Development Services Department
Planning Division
4970 City Hall Blvd.
North Port, FL 34286
O 941.429.7098
M 941.228.8879

www.cityofnorthport.com "Achieve Anything"

E-mail messages sent or received by City of North Port officials and employees in connection with official City business are public records subject to disclosure under the Florida Public Records Act.

CAUTION: This email originated from an external source. Be Suspicious of Attachments, Links and Requests for Login Information

Bryant Miller Olive

Attorneys at Law
One Tampa City Center
Suite 2700
Tampa, FL 33602
Tel 813.273.6677
Fax 813.223.2705
www.bmolaw.com

October 15, 2021

VIA PDF EMAIL

Amber L. Slayton, Esq., City Attorney
City of North Port
4970 City Hall Boulevard
North Port, Florida 34286
aslayton@cityofnorthport.com

Re: Heron Creek Land Use and Conversion Tables

Dear Amber:

You have requested that we provide the City of North Port ("City") with a written opinion on whether the Land Use Table contained in section 3.0 of Ordinance 2011-033 may be modified by the Developer to allow the transfer of land use entitlements from one phase to another phase.

I. Background

In responding to your request, we have reviewed the following materials provided by the City:

- Ordinances 2000-13, 2005-28, 2006-46, 2011-33, 2013-16;
- Resolution 01-R-5;
- Various emails and applications provided by the City;
- Biennial Status Report for Heron Creek (November 1, 2018 – October 31, 2020);
- September 7, 2021 letter from Dan Lobeck with attachments;

- September 20, 2021 letter from Morgan Bentley with documents referenced therein; and
- September 30, 2021 letter from Dan Lobeck with attachments;

A. Ordinance 2011 -33

On September 11, 2000, the City Commission ("Commission") adopted Ordinance 2000-13 as the development order for Heron Creek, a development of regional impact ("DRI"). Throughout time, this development order has been amended several times. On March 10, 2010, the developer requested to update Map H with existing and proposed development, address affordable house stipulations, revise the current stipulations relating to the proposed pathway along the Myakkahatchee Creek, and propose a land use conversion matrix that would allow the developer to convert approved uses from one area to another without increase in external impacts. Specifically, in the Notice of Proposed Change ("NOPC") that the developer revised in August of 2011, the developer explains that, due to changing market conditions in commercial development, the developer proposed a conversion matrix that would provide the developer flexibility in meeting the needs of the City and demands of the real estate market. The conversion matrix also demonstrates how residential, retail, offices and medical offices can be converted through the local development order process without exceeding thresholds that would trigger a substantial deviation to the DRI. The applicant proposed no change to the development intensity or the buildout or phasing dates of the project. On January 9, 2012, the Commission adopted Ordinance 2011-33 as the development order for Heron Creek ("Development Order").

The Development Order specifically provides the following:

3.01 The amended ADA for Heron Creek DRI is hereby approved for the following land uses and phases, and land use conversion matrix subject to the conditions contained herein consistent with the revised Map H (attachment 3 of the DO), and is subject to the other provisions of the Development Order (including Attachment 4 of DO):

Land Use	Phase I (97-2001)	Phase II (02-2006)	Phase III (07-2011)	Phase IV (12-2017)
Residential Single Family	275 DU	377 DU	251 DU	

(LUC 210)				
Residential Multifamily (LUC 220)	125 DU		175 DU	
Golf Course (LUC 430)	18 holes	9 holes		
Tennis Club (LUC 492)		5 Courts		
Medical/Professional (LUC 720)			43,000 GLA	
Office General (LUC 710)			40,000 GLA	
Retail Shopping Center (LUC 820)	90,000 GLA	30,000 GLA	488,000 GLA	137,500 GLA

The Land Use Table, as specified above, may be modified by the Developer without further amendment to this Development Order, subject to the following:

- a) This transfer or conversion may occur subject to the following conversion table: *(The conversion table showing conversion from and to each land use in the land use table is omitted from this letter due to space constraints but can be found in section 3.01 of the Development Order).*
- b) The transfer or conversion may occur provided that: 1) the external trips approved for the DRI remain the same and 2) no additional impact will occur to other public facilities (such as sewer and water). Further, no alteration to the Map H may occur as a result of the conversion.
- c) Forty-Five (45) day notice of any conversion must be provided to the City, the Department of Economic Opportunity, Division of Community Planning and Development, and the Southwest Florida Regional Planning Council. In addition, the amount of the conversion must be reported as part of the subsequent monitoring report and petition to develop. When a petition to develop which includes a transfer or conversion of land use is submitted to the City, proof that no adverse impact is being caused by the transfer or conversion or any combination thereof must be provided.

d) The transfer of conversion does not increase the allotted number of units on any particular parcel to a level above what is permitted in the DRI or the City of North Port Land Development Code and does not exceed the substantial deviation criteria of subsection 380.06(19)(b), F.S.

Regarding the conversion matrix, the Development Order included the Sufficiency Comments from the Developer that explained how the proposed conversion matrix was established to ensure there would be no impact to the regional transportation system when converting units. The City had expressed concern that the proposed conversion matrix could permit a greater number of housing units than was allowed within any zoning district and the Developer agreed with proposed restrictive language to alleviate the City's concern. Additionally, the Developer attached a Technical Memorandum from Tindale, Oliver, and Associates, which established the methods and background information for the conversion table estimates. Specifically, the conversion rates were determined by comparing the previously approved Phases 1-3 development program and corresponding external trip generation, to a proposed development program. The proposed development program would provide for additional retail entitlements concurrent with a decrease in or "trade-off" of other entitled uses (i.e. office and residential). As approved, the entitlements of the Heron Creek DRI were estimated to generate approximately 2,804 net external trips during the PM peak hour. The conditions of the Development Order limit development based on external trips, with improvements conditioned at various trip milestones. The analysis determined that an updated development mix, incorporating additional retail entitlements, would not result in additional net external trip generation from the DRI and provided the following example to demonstrate:

An additional 245 ksf of retail is estimated to increase net external trip generation by 513 vehicles per hour or 2.095 vehicles per hour/per ksf. The multi-family decrease of 767 dwelling units is estimated to decrease net external trip generation by the site by 372 vph, or .486 vehicles per dwelling unit. Therefore $2.095/.486 = 4.31$ multi-family dwelling units trade-off for 100 square feet for retail.

As explained in the Technical Memorandum, the intent of the change to the Development Order was not to eliminate any intended land uses from development, but rather to allow for the reallocation of the quantities that are approved based on changes in the market demand

The Development Order recognizes some of the land use entitlements have been developed (i.e. a grocery store) and improvements made (i.e. bus shelters and roads) while other land use entitlements from earlier, expired phases remain undeveloped (i.e. the Development Order recognizes that building permits for Phase II have not been issued and requires payment of application fees before their issuance even though the phase has expired)¹. The City is responsible for enforcement of the Development Order and the Development Order remains in effect until December 31, 2017, which is also the build out date. The Development Order further provides that the DRI shall not be subject to down-zoning, unity density reduction, or intensity reduction prior to December 31, 2017, unless the City of North Port can demonstrate that substantial changes in the conditions underlying the approval of the Development Order have occurred or that the Development Order was based on substantially inaccurate information provided by the developer, or the change is essential to the public health, safety, or welfare. Pursuant to information from City Staff and based on declarations of the state of emergency, the City subsequently extended the Development Order Phase IV and buildout date to March 9, 2024.

B. Ordinance 2013 -16

On October 14, 2013, the Commission enacted Ordinance 2013-16, which amended Section 4.10 of Ordinance 2011-33. This amendment provided for an additional local condition, where prior to any certificate of occupancy for any development beyond 286,000 gross square feet of development within the 84-acre parcel located at the southeast quadrant of Price and Sumter, the developer must construct an eight-foot-wide sidewalk including a pedestrian bridge over the Blueridge Waterway, if determined necessary by the City. At the time Ordinance 2011-33 was enacted, the developer had only received approval for the development of a 3,890 gross square feet McDonald's on the 84-acre parcel.

C. Subsequent Correspondence

On February 22, 2021, the City's Interim City Manager, sent a letter to the Developer regarding failure to comply with conditions of approval for Heron Creak DRI. Attached to that letter, the City listed 10 conditions where action was required. Two of the conditions were: 1) a biennial report was delinquent and 2) while the land use phasing

¹ Those fees were subsequently paid and building permits obtained nine months after the Development Order was approved.

chart with conversion matrix “is not out of date; ... staff would just like to take this opportunity to note that the applicant has utilized this condition to transfer the undeveloped land uses into Phase IV.”

Subsequently, the Developer filed its biennial status report for Heron Creek for the period of November 1, 2018 to October 31, 2020 (“Biennial Report”). The Biennial Report identified that the extension of the buildout date was granted during reporting period and minor changes to phasing dates and development allocation have been made as shown below.

Land Use	Phase I (97-2001)		Phase II (02-2006)		Phase III (07-2011)		Phase IV (12-2021)	
	Proposed	Actual	Proposed	Actual	Proposed	Actual	Proposed	Actual*
Residential Single Family (LUC 210)	275 DU 376 DU	376 DU	377 DU 457 DU	457 DU	251 DU		70 DU	
Residential Multifamily (LUC 220)	125 DU				175 DU		300 DU	133 DU
Golf Course (LUC 430)	18 holes	18 holes	9 holes	9 holes				
Tennis Club (LUC 492)			5 Courts	5 Courts				
Medical/Professional (LUC 720)					43,000 GLA		43,000 GLA	20,070 GLA
Office General (LUC 710)					40,000 GLA		40,000 GLA	
Retail Shopping Center (LUC 820)	90,000 GLA 68,075 GFA	68,075 GFA	30,000 GLA 34,240 GFA	34,240 GFA	488,000 GLA 3,890 GFA	3,890 GFA	137,500 GLA 639,295 GLA	102,374 GLA

*Staff provided the actual development in Phase IV to be 197 DU MF; 31,452 GLA medical; and 90,744 GLA retail.

Pursuant to Ordinance 2011-33, the total land use approved is 903 Single Family Residential units, 300 Multi-family unit, 27 Holes of Golf, 5 Tennis Courts, 43,000 SF of Medical/Professional, 40,000 SF of General Office and 745,500 SF of Retail Shopping

Center. Pursuant to the Biennial Report, the total land use constructed is 833 Single Family Residential units, 133 Multi-family units (48 independent living units and 169 ½ Continuing Care units), 27 Holes of Golf, 5 Tennis Courts, 20,070 SF of Medical/Professional, 0 SF Office General, and 206,579 SF of Retail Shopping Center.

The Developer submitted an application for development under Phase IV and the application caused the City to ask whether the Land Use Table contained in section 3.0 of Ordinance 2011-033 may be modified by the Developer to allow the transfer of land use entitlements from one phase to another phase. It's worth noting that neither "transfer" nor "conversion" are defined terms in the City's Code, or the applicable Ordinances described above.

II. Interpreting Development Orders

A development order shall be interpreted using the fundamental principles applicable to statutes and ordinances. *Trafalgar Woods Homeowners Assn., Inc. v. City of Cape Coral*, 248 So. 3d 282, 284 (Fla. 2d DCA 2018). Hence, where the language of a development order is plain and unambiguous, there is no room for construction or interpretation, and the effect of the development order must be determined according to the literal meaning of the language therein. *Killearn Properties, Inc. v. Dept. of Community Affairs*, 623 So. 2d 771, 775 (Fla. 1st DCA 1993); *Rinker Materials Corp. v. City of N. Miami*, 286 So. 2d 552, 553-54 (Fla. 1973). When a code does not define a term, Courts have turned to the dictionary meaning to find the plain and ordinary meaning of undefined terms. *Town of Longboat Key v. Islandside Prop. Owners Coal., LLC*, 95 So. 3d 1037, 1041 (Fla. 2d DCA 2012). However, Courts will not give an ordinance a literal interpretation that would produce an unreasonable or ridiculous conclusion. *License Acquisitions, LLC v. Debary Real Est. Holdings, LLC*, 155 So. 3d 1137 (Fla. 2014); *State v. Brogden*, 84 Fla. 520, 524, 94 So. 653, 654 (1922) ("While it is desirable that ordinances should be free from doubt, the court should strive so to construe them as to give reasonable effect to the object aimed at. Scrutiny unreasonably rigid will not be resorted to in considering the meaning of ordinances.")

In cases of ambiguity or doubt the meaning of the development order, courts are required to give effect to every word, phrase, sentence, and part of the ordinance, if possible, and words in an ordinance should not be construed as mere surplusage. *State v. Knighton*, 235 So. 3d 312 (Fla. 2018). Related provisions must be read together to achieve a consistent whole, and where possible, courts must give full effect to all ordinance provisions and construe related ordinance provisions in harmony with one another. *Id.*

Further, Courts generally may not insert words into municipal ordinances in order to express intentions which do not appear and must give to an ordinance the plain and ordinary meaning of the words employed by the City Commission. *Rinker Materials Corp. v. City of N. Miami*, 286 So. 2d 552, 553–54 (Fla. 1973). Courts are required to resolve doubts in the interpretation of an ordinance in a manner that will render the ordinance valid. *Lee Cty. v. Lippi*, 693 So. 2d 686, 689 (Fla. 2d DCA. 1997). The development order must be determined by that which preceded it and that which it was intended to execute. *MCZ/Centrum Flamingo II, LLC v. City of Miami Beach*, 08-22419-CIV, 2009 WL 10700922, at *17 (S.D. Fla. Aug. 12, 2009). If a development order cannot be interpreted from the language in the order itself, the entire record may be examined and considered for the purpose of interpreting the development order and determining its operation and effect. *Id.* Furthermore, deference is owed to a city commission's interpretation of its own rules and regulations "so long as its interpretation is based on a permissible construction." *Am. C.L. Union of Fla., Inc. v. Miami-Dade Cty. Sch. Bd.*, 557 F.3d 1177, 1228 (11th Cir. 2009). The city's interpretation of its own regulation is not only based on a permissible construction, but it may also be the only reasonable interpretation of that regulation. *Id.* Intent of the city commission in enacting a zoning ordinance is to be determined primarily from the language of ordinance itself and not from conjecture aliunde. *Rinker Materials Corp. v. City of N. Miami*, 286 So. 2d 552 (Fla. 1973). Since zoning regulations are in derogation of private rights of ownership, words used in a zoning ordinance should be given their broadest meaning when there is no definition or clear intent to the contrary and the ordinance should be interpreted in favor of the property owner. *Id.*

III. Legal Analysis

The Development Order is clear and unambiguous as to the total amount of land use that was approved for the site, the phases that were planned, and the ability of the Developer to modify the Development Order without further amendment of the Development Order, subject to the conditions of transfer or conversion. The Development Order was adopted in 2012, when the development was already in Phase IV. At that time, according to the Land Use Table, the Development Order approved 137,500 SF of retail. This is also when the conversion matrix was first included in the Development Order. The conversion matrix allows for each of the undeveloped land uses to be converted to one of the other uses. (Note: At that time, the Golf Course and Tennis Club land uses were completed and were not included in the conversion matrix). The Development Order also specifies that the Land Use Table may be modified by the Developer without amendment to the Development Order so long as the 4 conditions of transfer or conversion are followed. The Development Order specifically says, "transfer

or conversion.” This indicates that these terms have different meanings as related to the Development Order. It also is commonly understood that “conversion” and “transfer” are distinct terms. Several dictionaries define the words as follows:

- Transfer – to cause to pass from one to another, Merriam-Wester, <https://www.merriam-webster.com/dictionary/transfers>; to move from one place to another; to move something/somebody from one place to another, Oxford Learner’s Dictionaries, https://www.oxfordlearnersdictionaries.com/us/definition/english/transfer_1?q=transfer
- Conversion - the act of converting: the process of being converted; to change from one form or function to another, Merriam-Wester, <https://www.merriam-webster.com/dictionary/conversion>; the act or process of changing something from one form, use or system to another, Oxford Learner’s Dictionaries, <https://www.oxfordlearnersdictionaries.com/us/definition/english/conversion?q=Conversion>

Hence, the Development Order provides that the Developer may modify the Land Use Table by either: 1) converting land uses, meaning changing from one land use to another; or 2) transferring land uses, meaning moving land uses from one phase to another, in the Land Use Table. Any such modification, again, is subject to the four conditions of transfer or conversion. Therefore, it is clear from the plain, unambiguous commonly understood language of the Development Order taken in whole, that the Developer is permitted to transfer land uses amongst the phases so long as the four conditions of transfer or conversion are met.

Moreover, both the City, through enforcing its Development Order, and the Developer through its actions, have continually interpreted the Development Order to mean that the Developer could transfer land uses in the Land Use Table from one phase to another so long as the four conditions of transfer or conversion were met. This is demonstrated in numerous ways. First, the City approved 197 DU of multi-family, 31,452 GLA of medical and 90,744 GLA of retail for construction after the Development Order was entered into in 2012. This necessarily required a recognition that the Developer could transfer land uses from one phase to another. The Developer continues to apply for development of more retail and to reinstate approval of 180 multi-family units.

Additionally, more than a year after the Development Order was adopted, the City enacted Ordinance 2013-16. In Ordinance 2013-16, the City provided that development beyond 286,000 SF in the 84-acre parcel would trigger the requirement that the developer construct a pedestrian bridge. Without the ability to transfer undeveloped land uses into Phase IV, the developer would never have been able to develop more than 286,000 SF on the 84-acre parcel. If the developer could not have transferred land uses amongst phases and therefore could never have exceeded 286,000 SF on that parcel, then Ordinance 2013-16 would have been meaningless. Also, in the February 2021 correspondence, the City confirmed the Land Use Table was not out of date and noted that the Developer had utilized the transfer/conversion condition to transfer all undeveloped land uses into Phase IV. In the Biennial Report, the Developer provided an updated Land Use Table that shows the transfer of undeveloped land uses into Phase IV.

If the City had intended that the Development Order result in the Developer losing its entitlements to the undeveloped land uses in the phases of the Land Use Table, upon the expiration date of those phases, then the City would have drafted the Development Order accordingly. It also would not have specified that the DRI was not subject to unit density or intensity reduction prior to the build out date. Furthermore, the City would not have included a provision in the Development Order requiring payment of fees prior to the issuance of any building permits for Phase II because that phase would have already expired. Additionally, the City would have created a conversion table showing that only the undeveloped retail shopping center land use could be converted to the other uses because it was the only land use shown in the Phase IV.

It is clear from the plain language of the Development Order and consistent with actions of the Developer and the City in its enforcement of the Development Order and adoption of the amendment to the Development Order, that both the Developer and City have understood from 2012 to the present that the Development Order allows for the movement of land uses from one phase to another, so long as the four conditions of transfer or conversion are met.

II. Conclusion

It is our opinion, that the Development Order is clear and unambiguous as to the allowable development in Phase IV and the ability of the Developer to modify the Land Use Table by transferring land uses amongst the phases of the development without further amendment of the Development Order and subject to the conditions of transfer or conversion therein.

Amber L. Slayton, Esq.

October 15, 2021

Page 11

Should you need anything further on this matter, please feel free to contact us.
Thank you for providing us the opportunity to assist the City in this matter.

Sincerely,

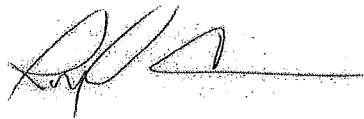
A handwritten signature in black ink, appearing to read "Jennifer R. Cowan", with a long horizontal line extending to the right.

Jennifer R. Cowan, B.C.S.
BRYANT MILLER OLIVE, P.A.